

# Vector Dominance Model for the $\pi\rho$ -System

---

Enno E. Scholz

University of Münster, Germany  
eMail: scholen@nwz.uni-muenster.de

*The Vector Dominance Model for the  $\pi\rho$ -System is an ansatz to state interactions by gauge theories. This report gives first a short introduction into Quantum Field Theory and Perturbation Theory with help of Feynman-Diagrams. The main part is to calculate the first order contribution to the self-energy of the  $\rho$ -meson in this model.*

## 1 Introduction

In this report<sup>1</sup> the relativistic formulation of physical theories (especially Quantum Field Theory) is needed. For a short review of this see: [8] or (more detailed) [4].

### 1.1 Quantum Field Theory

As in Classical Mechanics the Field Theory starts with the Variation Principle of the Lagrangian  $\mathcal{L}$ , which only depends on the field  $\phi$  and its first derivative  $\partial_\mu\phi$ . The action functional is defined as

$$S[\phi] = \int d^4x \mathcal{L} \quad (1)$$

So the variational principle becomes:

$$\frac{\delta S[\phi]}{\delta\phi} = 0 \quad (2)$$

---

<sup>1</sup> some conventions: all expressions are to be read in natural units ( $\hbar = c = 1$ ), also the Einstein convention is used: sum over all equal indices in one expression ( $x_\mu x^\mu = \sum_\mu x_\mu x^\mu$ ). The metric tensor is

$$g_{\mu\nu} = \begin{pmatrix} 1 & & & \\ & -1 & & \\ & & -1 & \\ & & & -1 \end{pmatrix}$$

This leads to the so called Euler-Lagrange equations:

$$\frac{\partial\mathcal{L}}{\partial\phi} - \partial_\mu \frac{\partial\mathcal{L}}{\partial(\partial_\mu\phi)} = 0 \quad (3)$$

From this the equations of motion can be derived. Another important topic in QFT are the so called global symmetry transformations. These are transformations, which do not depend on the space-time-coordinates (if a transformation is not independent of the space-time-coordinate it is called a local symmetry transformation, see 1.2) and do not change the Lagrangian  $\mathcal{L}$ . It can be shown (*Noether's Theorem*) that to each generator of a global symmetry group there belongs a conserved *Noether current* which is equivalent to a local formulation of a conservation law. Integrating the currents over a space-like hyper surface (especially over the space coordinates of an arbitrary reference frame) gives a conserved *Noether charge*.

Now let us have a look at the free *Klein-Gordon equation*  $(\square + m^2)\phi = 0$ , which is the first candidate for a relativistic formulation of Quantum Theory for free particles. The Lagrangian therefore reads:

$$\mathcal{L} = \frac{1}{2}\partial_\mu\phi\partial^\mu\phi - \frac{m^2}{2}\phi^2 \quad (4)$$

By using the Hamiltonian theory by introducing canonical momentum densities  $\Pi = \frac{\partial \mathcal{L}}{\partial_0 \phi}$  one finds the fundamental Poisson-brackets<sup>2</sup>:

$$\{\phi(t, \vec{x}), \Pi(t, \vec{y})\} = \delta^3(\vec{x} - \vec{y}) \quad (5)$$

$$\{\Pi(t, \vec{x}), \Pi(t, \vec{y})\} = 0 \quad (6)$$

$$\{\phi(t, \vec{x}), \phi(t, \vec{y})\} = 0 \quad (7)$$

The next step is to change the fields into operators:  $\tilde{\Phi}, \tilde{\Pi}$ ; with this eq. (5) becomes<sup>3</sup>:

$$\tilde{\Phi}(t, \vec{x}) \overleftrightarrow{\partial} \tilde{\Phi}(t, \vec{y}) = i\delta^3(\vec{x} - \vec{y}) \quad (8)$$

By using a Fourier decomposition and the so called *Feynman-Stueckelberg interpretation*, which interprets negative energy eigenvalues as positive eigenvalues of an antiparticle, the field can be written in the following way:

$$\tilde{\Phi}(x) = \int \frac{d^3 \vec{p}}{\sqrt{2\omega(\vec{p})} (2\pi)^3} \left[ \tilde{a}(\vec{p}) e^{-ipx} + \tilde{b}^\dagger(\vec{p}) e^{ipx} \right] \quad (9)$$

with:  $\omega(\vec{p}) = \sqrt{\vec{p}^2 + m^2}$   
 $p_0 = \omega(\vec{p})$

By using the commutator relations, one can show that  $\tilde{a}$  and  $\tilde{b}$  are the annihilation operators for different particles and  $\tilde{a}^\dagger, \tilde{b}^\dagger$  are the corresponding creation operators. So every operator can be built up from these creation and annihilation operators. In the further discussion it is useful to renormalize the expectation value of the vacuum state by introducing the so called *normal-ordering* product:  $:\dots:$ , which means, that all annihilation operators are ordered to the right side and all creation operators to the left<sup>4</sup>.

## 1.2 Gauge Theory

In the previous section (1.1) global symmetry transformations were mentioned. There also

<sup>2</sup>  $\{A, B\} = \int d^3 \vec{x} \left[ \frac{\partial A}{\partial \phi} \frac{\partial B}{\partial \Pi} - \frac{\partial A}{\partial \Pi} \frac{\partial B}{\partial \phi} \right]$

<sup>3</sup>  $f \overleftrightarrow{\partial} g = f \partial_t g - (\partial_t f) g$

<sup>4</sup> e.g.:  $:\tilde{a} \tilde{a}^\dagger \tilde{b} \tilde{b}^\dagger: = \tilde{a}^\dagger \tilde{a} \tilde{b}^\dagger \tilde{b}$

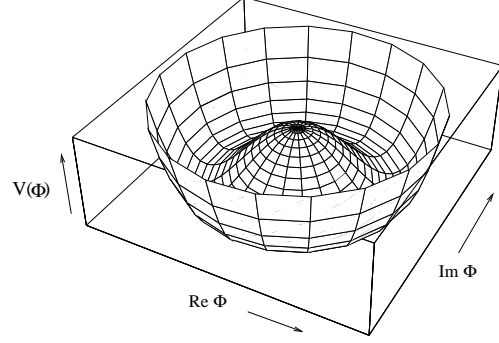

Fig. 1: Potential for the Higgs-Mechanism

exist *local* symmetry transformations, meaning that the behaviour of the transformation depends on the space-time coordinates, e.g.:

$$A(x) \longrightarrow A'(x') = U(x)A(U(x)x)$$

To leave the Lagrangian invariant under this kind of transformation, one has to use the so called *covariant derivative*  $D_\mu$  instead of  $\partial_\mu$ :

$$\partial_\mu \longrightarrow D_\mu = \partial_\mu + i\lambda A_\mu \quad (10)$$

The new vector field  $A_\mu$  is an isometry and sometimes called a connection, it creates interaction terms in the Lagrangian, and  $\lambda$  is the coupling constant for that interaction. This is a very convenient way to introduce interactions in QFT (e.g. in Quantum Electrodynamics). For details see [11] and [3].

The so introduced gauge bosons in these local gauge theories are always massless. To get rid of this, one can use the so called *Higgs-mechanism*, which deals with a spontaneous breaking of the symmetry of the ground state. The general idea is, that the ground state does not obey the symmetry of the Lagrangian (this also implies that the groundstate is degenerated). An example for this is the potential (see also fig. 1))

$$V(\Phi) = -\frac{\mu^2}{2} \Phi^* \Phi + \frac{\lambda}{4} (\Phi^* \Phi)^2 \quad (11)$$

which is used to construct the  $\pi\rho$ -System (see [7]) discussed below (3).

## 2 Perturbation Theory and Feynman Diagrams

### 2.1 Perturbation Theory

In perturbation theory one looks at a Lagrangian which can be interpreted as a free Lagrangian with a small interaction term, called the perturbation:

$$\mathcal{L} = \mathcal{L}_0 + \mathcal{L}_{per} \quad (12)$$

A good example for this is the  $\phi^4$ -Theory, where  $\mathcal{L}_{per} = -\frac{\lambda}{4!}\phi^4$ . In the following we will have a look at the Hamiltonian, which also can be splitted in a free one and a perturbation term

$$\begin{aligned} \mathcal{H} &= \mathcal{H}_0 + \tilde{V} \quad (13) \\ \mathcal{H}_0 &= \int d^3\vec{x} : \tilde{\Pi}\partial_0\tilde{\Phi} - \mathcal{L}_0 : \\ \tilde{V} &= - \int d^3\vec{x} : \mathcal{L}_{per} : \end{aligned}$$

The most interesting quantity addressed in perturbation theory is the S-matrix (scattering-matrix)  $\tilde{S}_{fi}$  which is the transition matrix between an initial state  $i$  and a final state  $f$ . These initial and final states are supposed to be asymptotically free states, i.e. eigenstates for  $t \rightarrow \pm\infty$  respectively, of  $\mathcal{H}_0$ . As in ordinary quantum mechanics the time evolution reads:<sup>5</sup>

$$|i, t\rangle = T_c \exp \left[ -i \int_{t_0}^t d\tau \tilde{V}(\tau) \right] |i, t_0\rangle \quad (14)$$

So  $\tilde{S}$  becomes:

$$\tilde{S} = T_c \exp \left[ -i \int_{-\infty}^{\infty} d\tau \tilde{V}(\tau) \right] \quad (15)$$

<sup>5</sup> The operator  $T_c$  means the time-ordering operator, for this only is meant to be a short introduction for details look at [12]

This term can be expanded in a power series, e.g. in  $\phi^4$ -theory:

$$\begin{aligned} \tilde{S} &= 1 + \sum_{n=1}^{\infty} \frac{1}{n!} \left( -\frac{i\lambda}{4!} \right)^n \\ T_c \int d^4x_1 \dots d^4x_n : \phi^4(x_1) : \dots : \phi^4(x_n) : \end{aligned} \quad (16)$$

By using the creation and annihilation operators (see 1.1) to express the initial and final states the matrix element  $S_{fi}$  can be written as the following:

$$S_{fi} = \langle 0 | \prod_{j=1}^{n_f} \tilde{a}(\vec{q}_j) \tilde{S} \prod_{k=1}^{n_i} \tilde{a}^\dagger(\vec{p}_k) | 0 \rangle \quad (17)$$

Now there are some useful formulas about time-ordered products of normal ordered operators. The first is the so called *LSZ Reduction Formula*<sup>6</sup>, with help of the n-point Greens-function, which can be seen as propagator which connects the n space-time points,

$$iG^{(n)}(x_1, \dots, x_n) = \langle 0 | T_c \tilde{\Phi}(x_1) \dots \tilde{\Phi}(x_n) | 0 \rangle \quad (18)$$

and the assumption that in the remote past and future the fields are asymptotically free, it can be found after some calculations (see [8]) that

$$\begin{aligned} S_{fi} &= \text{disc.} + \left( \frac{i}{\sqrt{Z}} \right)^{n+l} \int \prod_{a=1}^k \varphi_{\vec{q}_a}^*(y_a) \prod_{b=1}^l \varphi_{\vec{q}_b}(y_b) \\ &\quad \prod_{c=1}^k (\square_{y_k+m^2}) \prod_{d=1}^l (\square_{y_l+m^2}) iG^{(k+l)}(y_1, \dots, y_k, x_1, \dots, x_l) \end{aligned} \quad (19)$$

where  $\varphi$  means a free state solution of the Hamiltonian,  $Z$  is a constant for normalization and disc. means disconnected parts, that is the situation if one or more particles are not scattered (because of this is not interesting, it is not written out here).

The next useful formula is the so called *Dyson-Wick Series*, which tells one how to

<sup>6</sup> derived by Lehmann, Symanzik and Zimmermann

change from the Heisenberg picture (time independent wave functions, operators time dependent) to the interaction picture (for details see [12] or [6]):

$$\begin{aligned} \langle 0 | \tilde{S} | 0 \rangle iG^{(n)}(x_1, \dots, x_n) &= \\ = \langle 0 | T_c \tilde{\phi}(x_1) \dots \tilde{\phi}(x_n) \exp \left[ -i \int d\tau \tilde{V}(\tau) \right] | 0 \rangle \end{aligned} \quad (20)$$

The last theorem we need for the following discussion is *Wick's Theorem*, which allows us to calculate the time ordered product operators. For this a field operator will be split into a creation and an annihilation part:  $\tilde{\phi} = \tilde{\phi}_+ + \tilde{\phi}_-$ . Furthermore we introduce the contraction of two operators (signed by a star right to them) by

$$T_c \tilde{U} \tilde{V} = : \tilde{U} \tilde{V} : + \tilde{U} \star \tilde{V} \star \quad (21)$$

It can be calculated that<sup>7</sup>

$$\begin{aligned} \tilde{U} \star \tilde{V} \star &= \theta(t_1 - t_2) \left[ \tilde{\phi}_+(x_1) \tilde{\phi}_-(x_2) \right] \\ &\quad + \theta(t_2 - t_1) \left[ \tilde{\phi}_+(x_2) \tilde{\phi}_-(x_1) \right] \\ &= i\Delta_F(x_1 - x_2) \end{aligned} \quad (22)$$

This term is called the *Feynman-propagator* and can be calculated by using the Fourier transformation. It can be proved by complete induction that

$$T_c \tilde{A} \dots \tilde{Z} = : \tilde{A} \dots \tilde{Z} : + : \text{sum over all possible contractions}^8 : \quad (23)$$

## 2.2 Feynman Diagrams

Now one only has to apply eq. (16) to eq. (20):

$$\begin{aligned} iG^{(n)}(x_1, \dots, x_n) \langle 0 | \tilde{S} | 0 \rangle &= \\ = \langle 0 | T_c \tilde{\Phi}(x_1) \dots \tilde{\Phi}(x_n) \sum_{k=0}^{\infty} \frac{1}{k!} \left( -\frac{i\lambda}{4!} \right)^k \\ \int d^4 y_1 \dots d^4 y_k : \tilde{\Phi}^4(y_1) \dots : \tilde{\Phi}^4(y_k) : | 0 \rangle \end{aligned} \quad (24)$$

<sup>7</sup> here  $\theta(x)$  is the step-function:  $\theta(x) = \begin{cases} 0 & x < 0 \\ 1 & x \geq 0 \end{cases}$

<sup>8</sup> e.g.:  $T_c \tilde{A} \tilde{B} \tilde{C} = : \tilde{A} \tilde{B} \tilde{C} : + : \tilde{A} \star \tilde{B} \star \tilde{C} : + : \tilde{A} \star \tilde{C} \star \tilde{B} : + : \tilde{A} \tilde{B} \star \tilde{C} \star :$

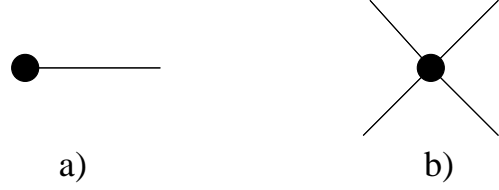

Fig. 2: Feynman-graphs in  $\phi^4$ -theory: a) outer point, b) inner point (4-vertex)

The next step is to apply *Wick's Theorem* (eq. (23)) and to keep in mind that the expectation values with respect to the vacuum state of not fully contracted operators always vanish. Now to find all contractions the *Feynman diagrams* are introduced: one draws a point with one leg for every outer space-time point (such as  $\tilde{\Phi}(x_1)$ ) and a 4-vertex for every inner point (the number of inner points determines the order of the contribution in terms  $\lambda^k$ ). With further calculations it can be shown, that only such diagrams contribute to the result, which do not contain any disconnected parts<sup>9</sup>. With help of the so called *Feynman-rules* one can read off the expression from these diagrams. For example here are the Feynman-rules for  $\phi^4$ -theory in momentum-representation:

- for each vertex write a factor  $-\frac{i\lambda}{4!}$
- each propagator line carries an internal or external momentum  $p_j$  and represents a factor  $iD_F(p_j) = \frac{i}{p^2 - m^2 + i\epsilon}$
- the total external momentum has to be conserved, also at every vertex momentum conservation has to be fulfilled.
- multiply with a symmetry factor<sup>10</sup>
- integrate over all internal momenta not fixed due to momentum conservation:  $\int \frac{d^4 k}{(2\pi)^4}$

Now there is a problem in calculating these integrals: In almost all cases if they contain so

<sup>9</sup> that means parts which have no connection to an outer point

<sup>10</sup> this factor takes care of various permutations of contractions for one diagram giving the same result

called “loops” (see fig. 3): they are divergent! To handle this problem one can assume that the parameters entering in the Lagrangian are so called *bare* parameters which cannot be observed. The observed *physical* parameters are different from them. So one has to add so called counter-terms to the Lagrangian, which are of the same form as the given ones, to make the integrals non-divergent. This is called *renormalization*. At first this may look a little bit arbitrary, but think of the normalization constants in quantum theory: one always *renormalizes* the expectation value for the whole volume to 1! The main idea is the existence of the *bare* parameters and that these cannot be measured, because there are always interactions between particles. So one can never observe a *free* particle with the *bare* parameter, just *interacting* particles can be observed and they show the *physical* parameter.

First one has to give the integrals a proper meaning of all which is called regularization. One way to do this is to use dimensional regularization<sup>11</sup> (see [8]). Here one introduces the dimension of space-time as a parameter  $2\omega$ , calculates the integrals which are divergent for  $2\omega \rightarrow 4$  and then handles them as analytic functions in the complex  $\omega$ -plane and expands them around the pole  $2\omega = 4$ . This will not be shown in detail in this short report, only the final results will be discussed. The reason for choosing this renormalization technique is the fact, that symmetries and most importantly gauge invariance are preserved by applying dimensional regularization. Another reason is practical convenience. But the first is much more important, because the interactions are stated by symmetries.

### 3 Self-Energies

In the following a model of the  $\pi\rho$ -system is treated as discussed in [7]. By using dimen-

<sup>11</sup> first it is convenient to apply so called *Wick's rotation* to change to an Euclidean field theory (see [8])

sional regularization, the one-loop contribution (see fig. 3) to the mass parameter is calculated for the  $\pi\rho$ -System.

### 3.1 Calculation of the first order contributions

For calculating the first order contributions (see fig. 3) to the self energies of the  $\rho$ -meson the following propagators and vertices are needed (see fig. 4):

$$\pi\text{-propagator } iG_\pi(l) = \frac{i}{l^2 - m_\pi^2 + i\epsilon}$$

$$\rho\pi\pi\text{-vertex}^{12} \quad i\Gamma_{\rho\pi\pi}(p, q) = -ig(p_\mu + q_\mu)$$

$$\rho\rho\pi\pi\text{-vertex} \quad i\Gamma_{\rho\rho\pi\pi} = ig^2 g^{\mu\nu}$$

Using this one can calculate the following expressions with help of the *dimensional regularization* technique.

$$\text{one-loop} = \int \frac{d^{2\omega}l}{(2\pi)^{2\omega}} (i\Gamma_{\rho\pi\pi}(l, l+p))^2 iG_\pi(l) iG_\pi(l+p) \quad (25)$$

$$\text{tad-pole} = 2 \int \frac{d^{2\omega}l}{(2\pi)^{2\omega}} i\Gamma_{\rho\rho\pi\pi} iG_\pi(l) \quad (26)$$

Doing all the calculations one gets the final result (sum of eq.(25) and eq.(26)):

$$-i\Pi(s) \left( \frac{p_\mu p_\nu}{s} - g_{\mu\nu} \right) \quad (27)$$

with:  $s = p^2$  and

$$\begin{aligned} \Pi(s) = & g^2 \frac{m_\pi^2}{6\pi^2} + C_w s \\ & + g^2 \frac{s - 4m_\pi^2}{24\pi^2} \sqrt{\left| 1 - \frac{4m_\pi^2}{s} \right|} \times \\ & \times \begin{cases} \operatorname{arccoth} \left( \sqrt{1 - \frac{4m_\pi^2}{s}} \right) & s < 0 \\ \operatorname{arccot} \left( \sqrt{\frac{4m_\pi^2}{s} - 1} \right) & 0 \leq s \leq 4m_\pi^2 \\ \operatorname{artanh} \left( \sqrt{1 - \frac{4m_\pi^2}{s}} \right) & s > 4m_\pi^2 \end{cases} \quad (28) \end{aligned}$$

<sup>12</sup> from now on the coupling constant is called  $g$  (do not mix this with the metric tensor  $g^{\mu\nu}$ )

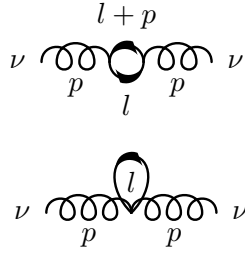

Fig. 3: One-loop contributions to the  $\rho$ -selfenergy (one-loop, tad-pole)

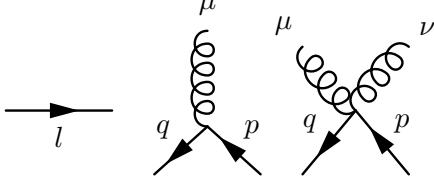

Fig. 4: Diagrams needed for the calculation ( $\pi$ -propagator,  $\rho\pi\pi$ -vertex,  $\rho\rho\pi\pi$ -vertex)

The infinite part is contained in  $C_w$  which reads<sup>13</sup>

$$C_w = g^2 \frac{s}{\pi^2} \left( -\frac{1}{18} + \frac{1}{48}\gamma - \frac{1}{48} \ln \frac{m_\pi^2}{\mu^2} - \frac{1}{48\epsilon} \right) \quad (29)$$

In eq. (28) it has already been taken into account by an analytic expansion, that there exists a pole in the complex  $s$ -plane at  $s = 4m_\pi^2$ . That is just the energy needed to produce the two  $\pi$ -mesons.

Now to get rid of the infinity one has to add this as a counter term to the Lagrangian and therefore gets the renormalized mass of the  $\rho$ -meson

$$m_{\rho,\text{ren}}^2 = m_\rho^2 + \Pi(s) \quad (30)$$

### 3.2 Experimental Data

To compare the (first order) corrections to the mass parameter derived by the renormalization ansatz, it is useful to look at scattering processes of pions, like the elastic scattering  $\pi^+ + \pi^- \rightarrow \pi^+ + \pi^-$ , with the

<sup>13</sup>  $\gamma$  is Euler's constant,  $\mu$  is an energy scale

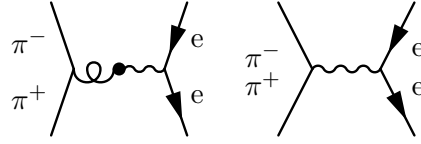

Fig. 5: Electron Form Factor (ratio of these two diagrams)

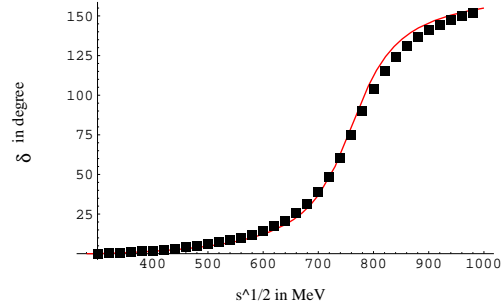

Fig. 6: Scattering Phase

first order contribution of the intermediate  $\rho$ -vectormeson. Therefore one has to look at the transfer matrix<sup>14</sup> for this process. The isospin in this process is fixed to  $J = 1$  (charged particles) and it is convenient to look at the channel with angular momentum fixed to  $l = 1$  because in this energy range the  $\rho$ -mesons are dominant (otherwise one has to take into account the mixing of the state with  $\omega$ -mesons). The complete evaluation of the scattering phase can be looked up in [7]. In figure 6 the data<sup>15</sup> are plotted and compared to the theoretical evaluation.

Another attempt to test the theoretical values is the examination of the electromagnetic form factor of the pion, which is defined by the ratio between the real  $\rho\gamma$ -Vertex, where a  $\rho$ -meson occurs and a vertex in which the interaction is direct. (see fig. 5). An experimental test could be made by examining the  $\pi^+ + \pi^- \rightarrow e^+ + e^-$  scattering process. The data<sup>16</sup> and the fitted values are shown in fig. 7.

<sup>14</sup> in principle the same as a scattering matrix, but one uses "transfer" because in the end you stay with the same particles

<sup>15</sup> measured by C.D. Frogatt, J.L. Petersen see [5]

<sup>16</sup> measured by S. Amendolia et al., see [1] and L.M. Barkov et al., see [2]

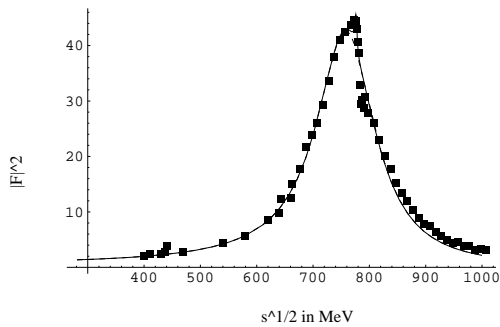

Fig. 7: Form Factor

## Acknowledgments

First I have to mention *Hendrik van Hees*, my tutor for this project at *GSI*, who spent a lot of time answering all my questions about QFT and other things. Also I want to thank the organizers and lecturers of this program.

## References

- [1] S. Amendolia et al., *Measurement of the Pion Form Factor in the Timelike Region for  $q^2$  Values between  $0.1(\text{GeV}/c)^2$  and  $0.18(\text{GeV}/c)^2$* , Phys. Lett. **138B** (1984) 454
- [2] L.M. Barkov et al., *Electromagnetic Pion Form Factor in the Timelike Region*, Nucl. Phys. **B256** (1985) 365
- [3] P. Becher, M. Böhm, H. Joos, *Eichfeldtheorien der starken und elektroschwachen Wechselwirkung*, Teubner (1983)
- [4] J.D. Bjorken, S.D. Drell, *Relativistische Quantenfeldtheorie*, BI-Wissenschaftsverlag (1984)
- [5] C.D. Frogatt, J.L. Petersen, *Phase Shift Analysis of  $\pi^+\pi^-$  Scattering between 1.0 and 1.8GeV Based on Fixed Transfer Analyticity (II)*, Nuclear Physics **B129** (1977) 89
- [6] W. Greiner, *Feldquantisierung*, Thun (1993)
- [7] H. van Hees, *Quantentheoretische Beschreibung des  $\pi\rho$ -Systems*, Diplomarbeit, TU Darmstadt, Inst. für Kernphysik (1997)
- [8] H. van Hees, *Introduction to Relativistic Quantum Field Theory*, <http://theory.gsi.de/~vanhees/publ/lect.ps.gz> (1999)
- [9] F. Klingl, *Untersuchungen zur Struktur der Vektormesonen*, Diplomarbeit, U Regensburg, Inst. I - Theoretische Physik (1995)
- [10] N.M. Kroll, T.D. Lee, B. Zumino, *Neutral Vector Mesons and the Hadronic Electromagnetic Current*, Physical Review **157** (1967) 1376
- [11] U. Mosel, *Fields, Symmetries and Quarks*, Springer (1999)
- [12] M. E. Peskin, D. V. Schroeder, *An Introduction to Quantum Field Theory*, Perseus Books (1995)