

- heavy-ion collisions & QGP
- heavy-ion collisions @ LHC
- **ALICE**
 - overview
 - selected physics performance
 - installation
 - first data taking

The QCD phase diagram

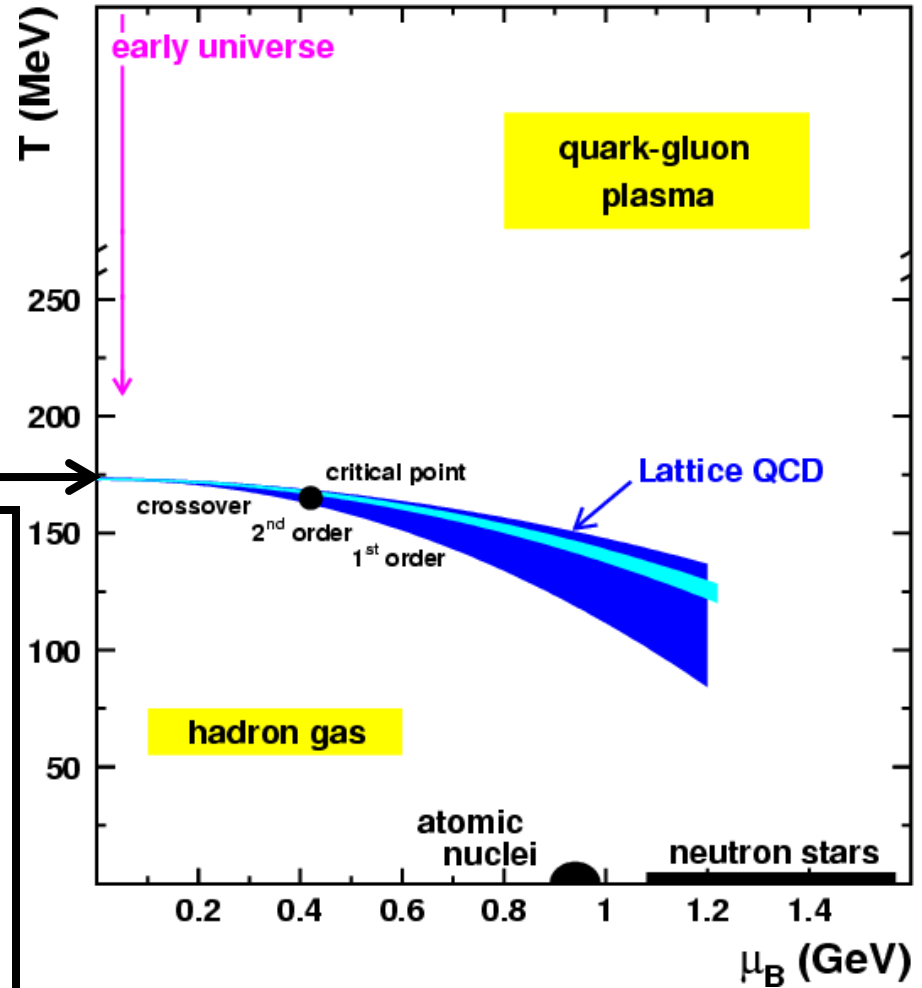
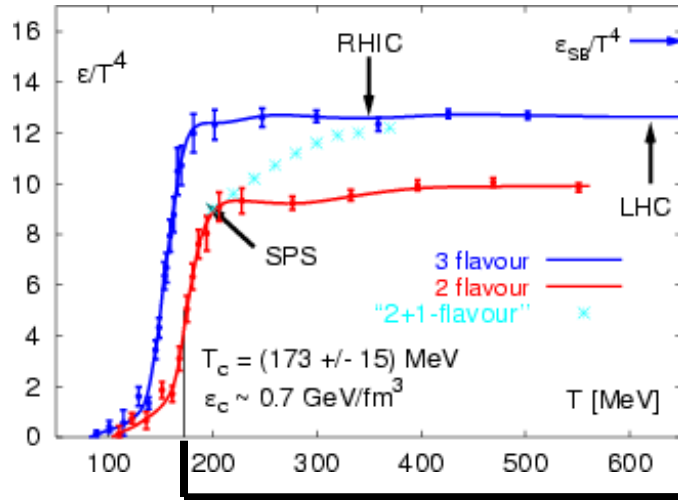
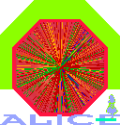

- $\mu_B = 0$:
 - $T_c = 173 \pm 15$ MeV
 - $\epsilon_c = 0.7 \pm 0.3$ GeV/fm³
 - “crossover”-like transition
- $\mu_B > 0$:
 - large uncertainties
 - order of transition unknown
 - existence of a critical point
- chiral sym. rest. coincides with deconf.
- the QGP is not an ideal gas
- $\mu_B \gg 0$: color superconductivity (not shown)

Recreating the QGP with heavy-ion collisions

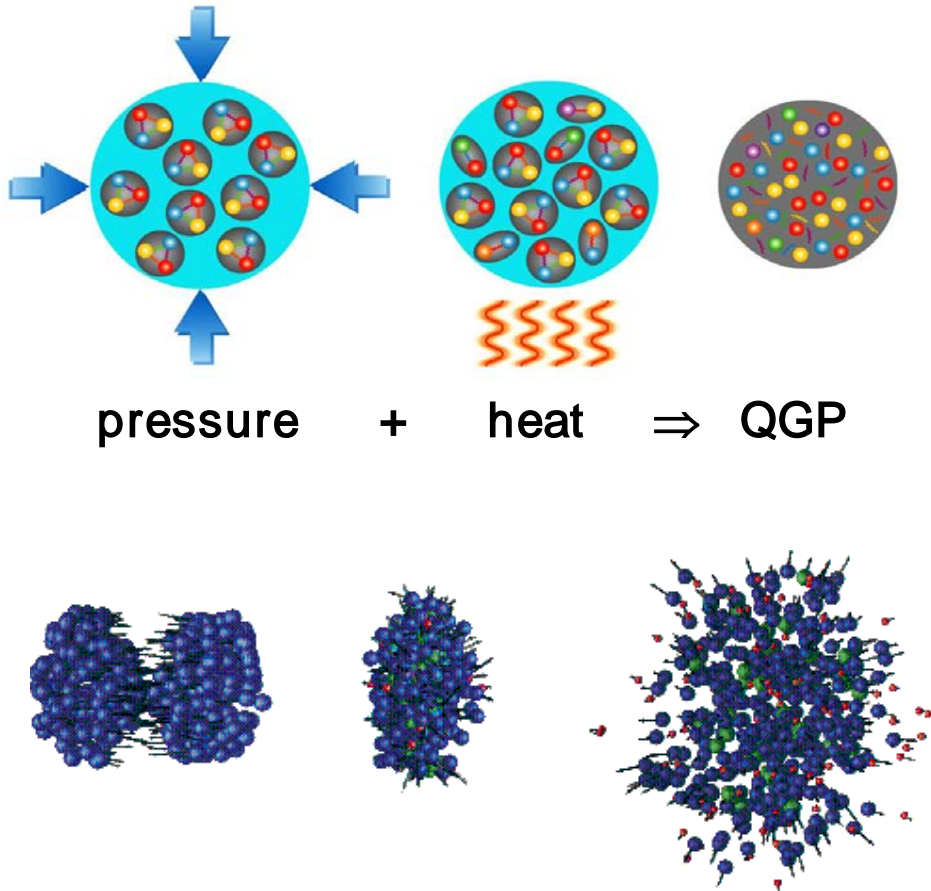
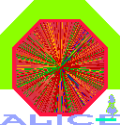

pressure + heat \Rightarrow QGP

key parameters: bombarding energy, collision centrality, particle transverse momentum

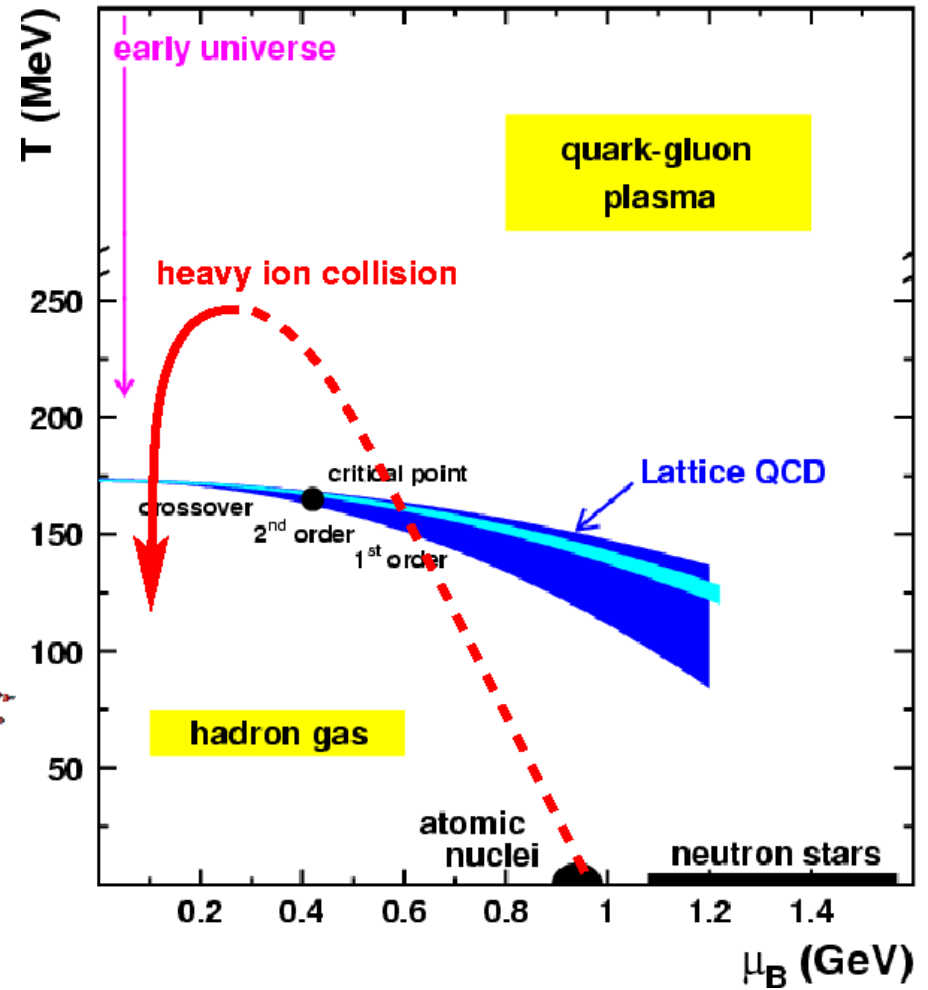

Space-time evolution of a heavy-ion collision

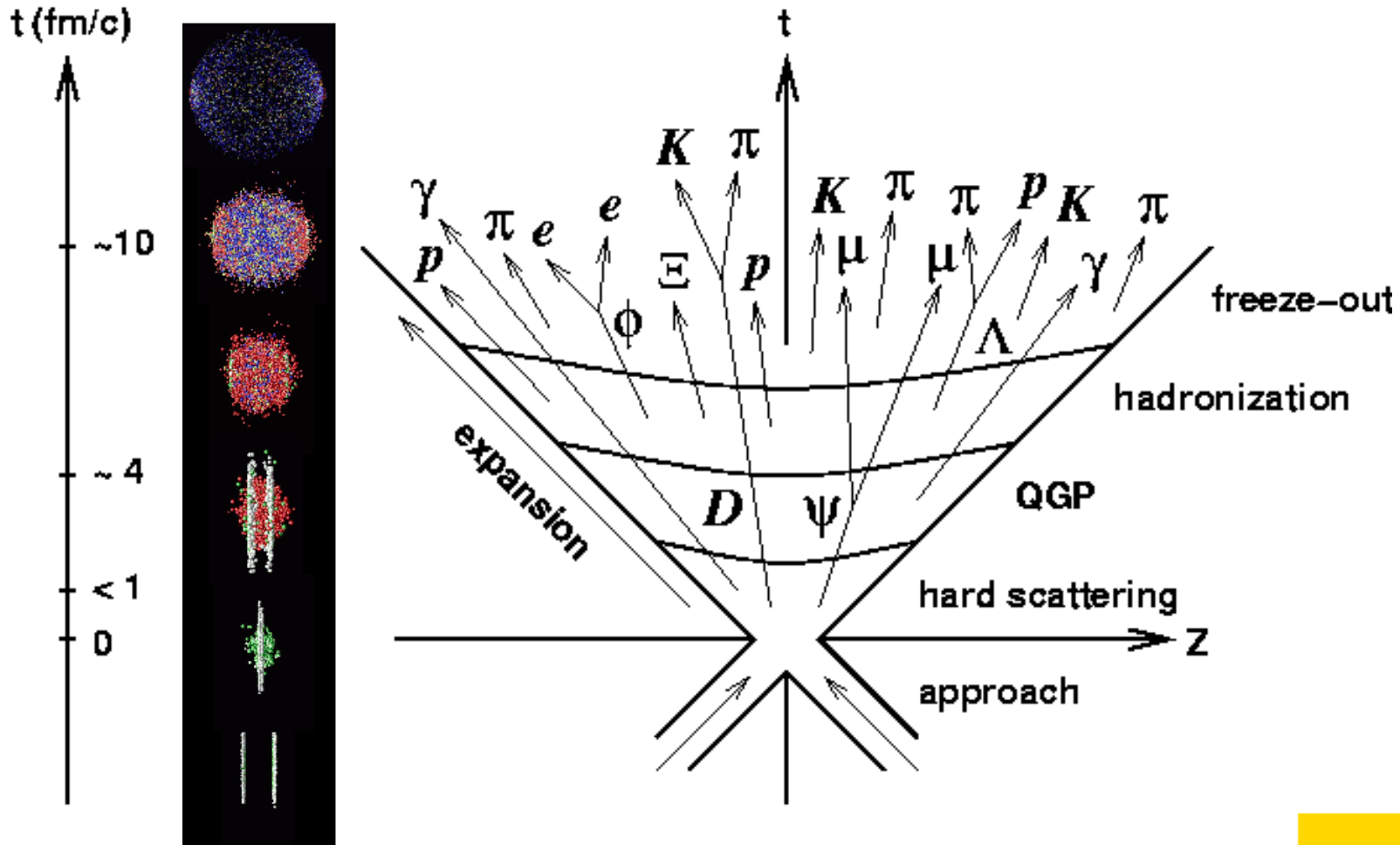
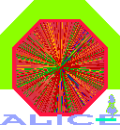

- 4 main “distinct” phases
- strategy: use produced particles as probes of the medium



QGP signatures

modification of low-mass resonances

suppression of high-mass resonances

strangeness enhancement

photon production

jet quenching

hard probes

based on particles produced in the early stage

soft probes

based on particles produced in the late stage

flow profile

..etc

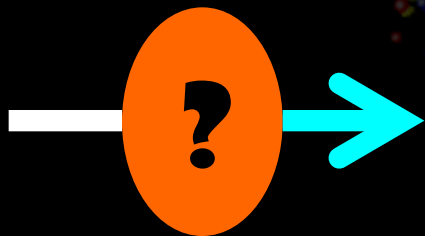

“direct” info from the medium

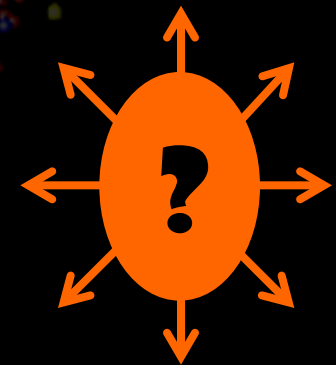
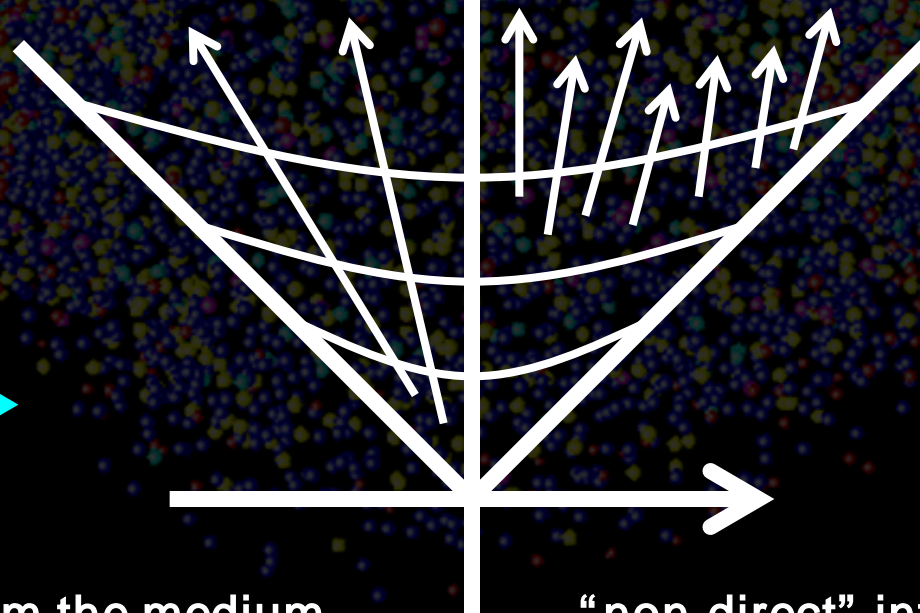

“non-direct” info from the medium

1975-2010: 35 years of heavy-ion collisions

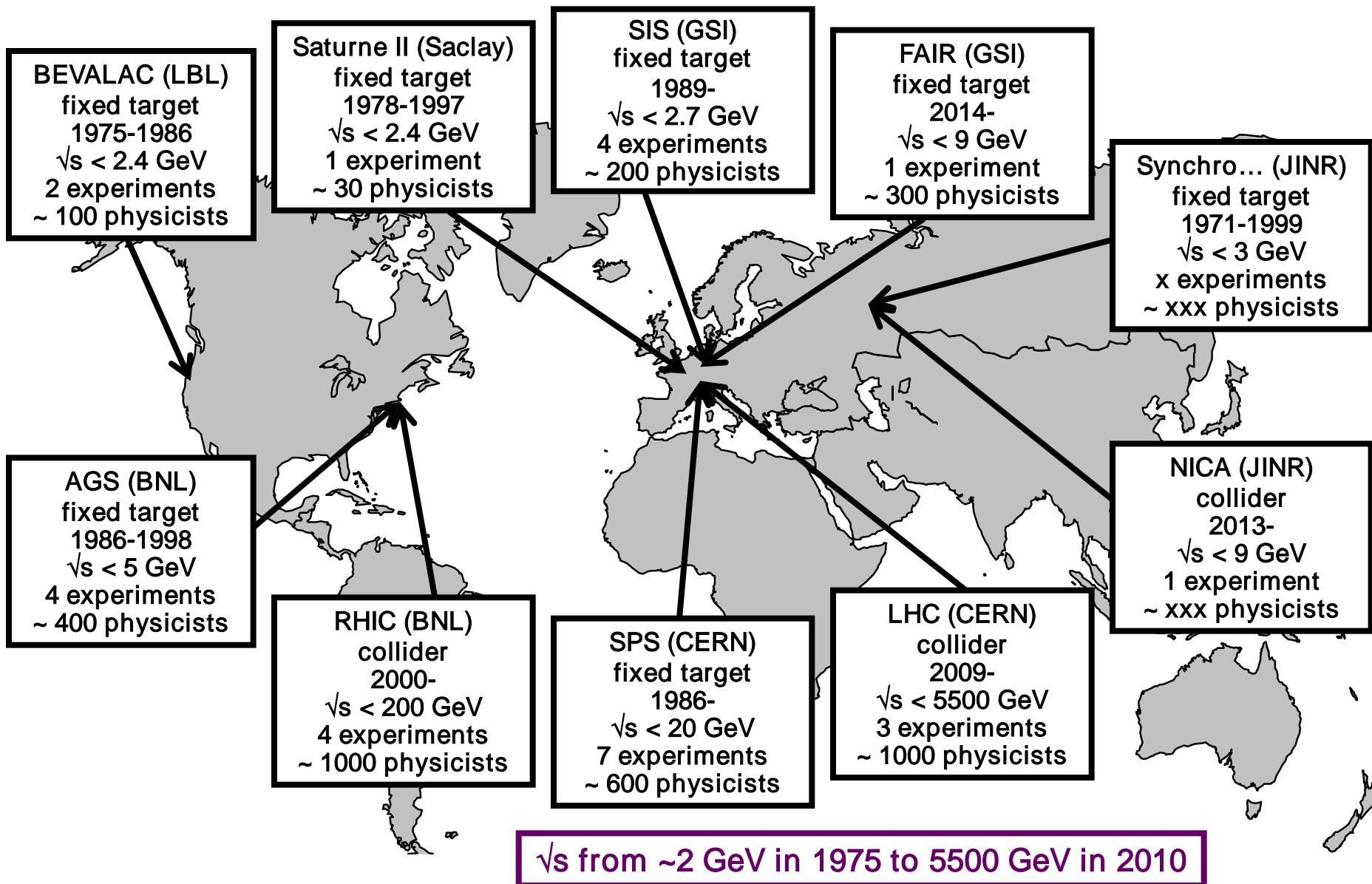
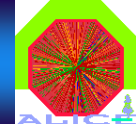

Can one reach the QGP with heavy-ion collisions?

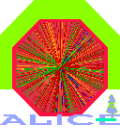

- freeze-out temperature

$$n_i = \frac{g}{2\pi^2} \int_0^\infty \frac{p^2 dp}{e^{(E_i(p) - \mu_i)/T} \pm 1}$$

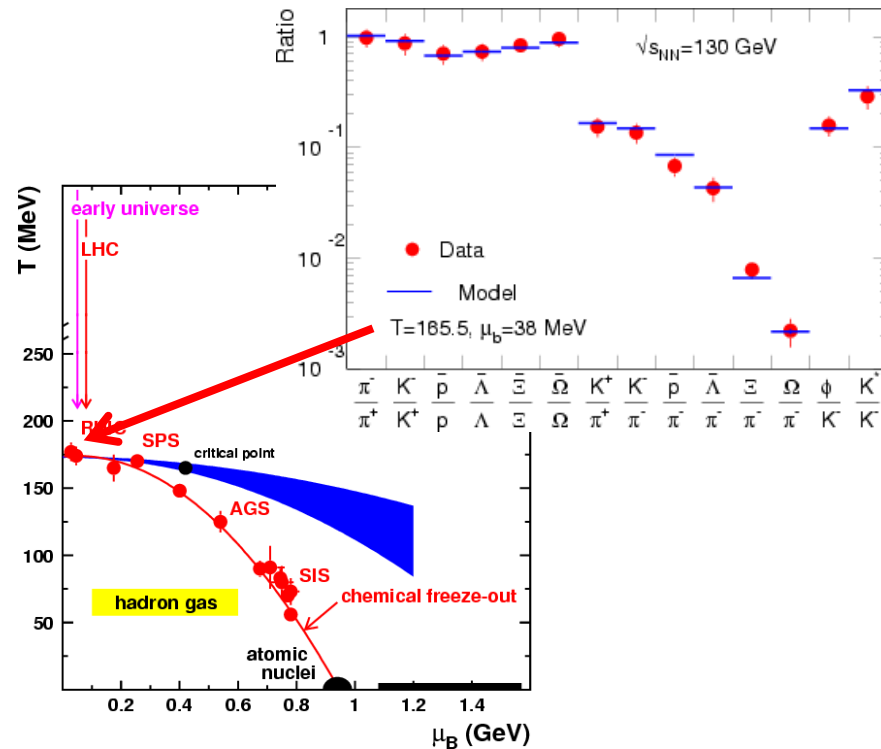

...coincides with critical value (173 MeV)

- energy density

$$\varepsilon_{Bj} = \frac{1}{\pi R^2} \frac{1}{\tau_0} \frac{dE_T}{dy}$$

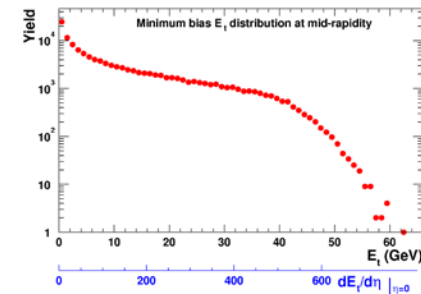
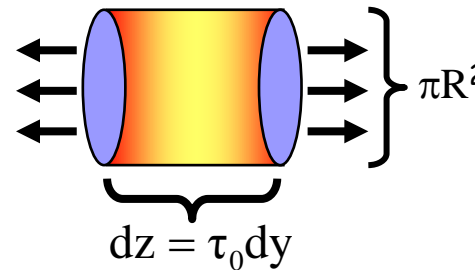

system	\sqrt{s} (GeV)	ε (GeV/fm ³)
Pb+Pb	17	2.5
Au+Au	200	4.6

...larger than critical value (0.7 GeV/fm³)

SPS & RHIC findings in 8 plots

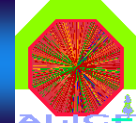

the medium produced in heavy-ion collisions:

1. has an energy density $>$ than ϵ_c
2. has a freeze-out temperature $\sim T_c$
3. over-produces strangeness
4. modifies properties of low-mass resonances
5. dissolves high-mass resonances
6. over-produces photons
7. exhibits quark & gluon degrees of freedom
8. quenches jets

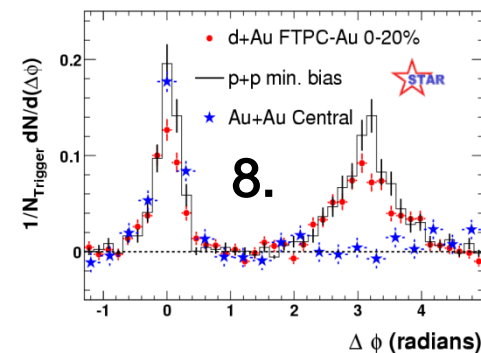
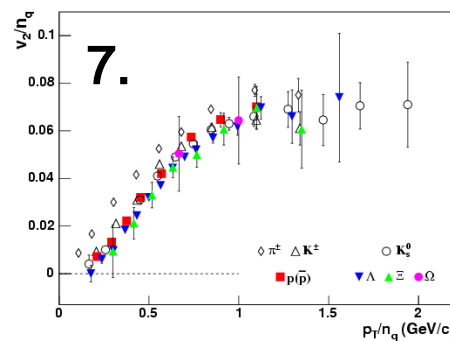
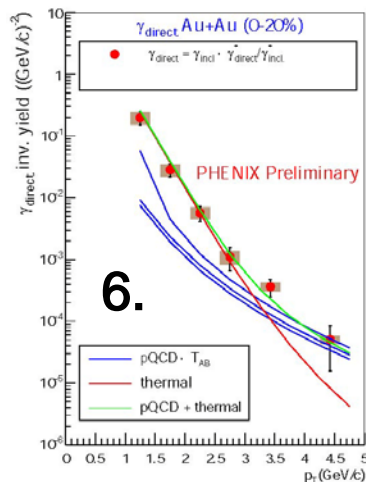
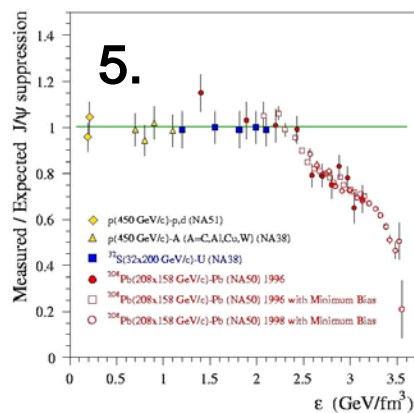
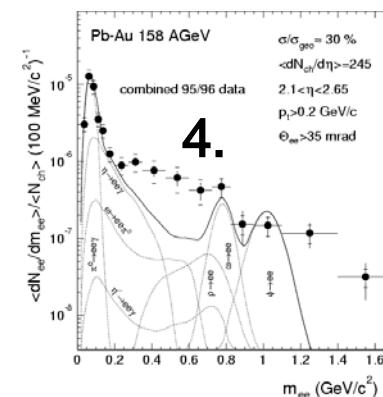
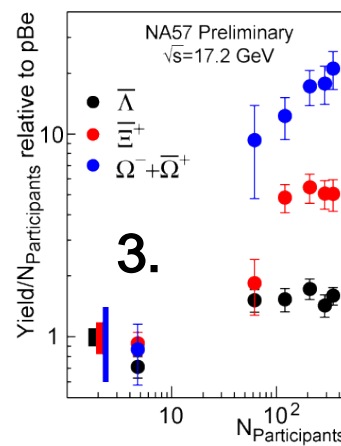
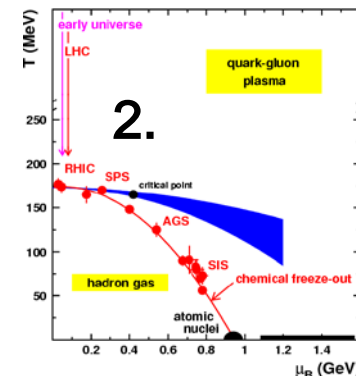
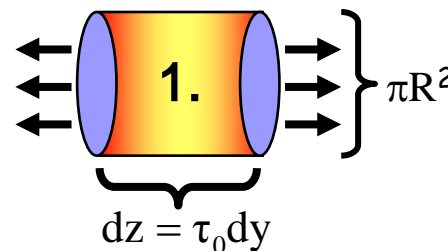

the medium behaves like a quark-gluon plasma

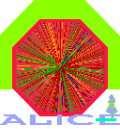

assumption: QGP has been established @ RHIC prior to LHC

SEARCH for the QGP may be essentially over

DISCOVERY of the QGP is well under way

MEASURING QGP parameters has hardly begun

QGP @ LHC versus RHIC = Z/W @ LEP versus SppS

the LHC is the ideal place for studying the QGP (next slide)

Heavy-ion collisions & QGP @ LHC



the biggest step in energy in the history of heavy-ion collisions

machine	SPS	RHIC	LHC
\sqrt{s} (GeV)	17	200	5500
N_{ch}	1000	4000	50 000
τ^0_{QGP} (fm/c)	1	0.2	0.1
T/T_c (τ^0_{QGP})	1.1	1.9	3.0-4.2
$\varepsilon[1 \text{ fm/c}]$ (GeV/fm ³)	3	5	15-60
τ_{QGP} (fm/c)	≤ 2	2-4	≥ 10
τ_f (fm/c)	~ 10	20-30	30-40
V_f (fm ³)	$\sim 10^3$	$\sim 10^4$	$\sim 10^5$
μ_B (MeV)	250	20	1
processes	soft \rightarrow semi-hard \rightarrow hard		

= 0.18 mJ

\Rightarrow faster

\Rightarrow hotter

\Rightarrow denser

\Rightarrow longer

\Rightarrow bigger

\Rightarrow cleaner

\Rightarrow harder

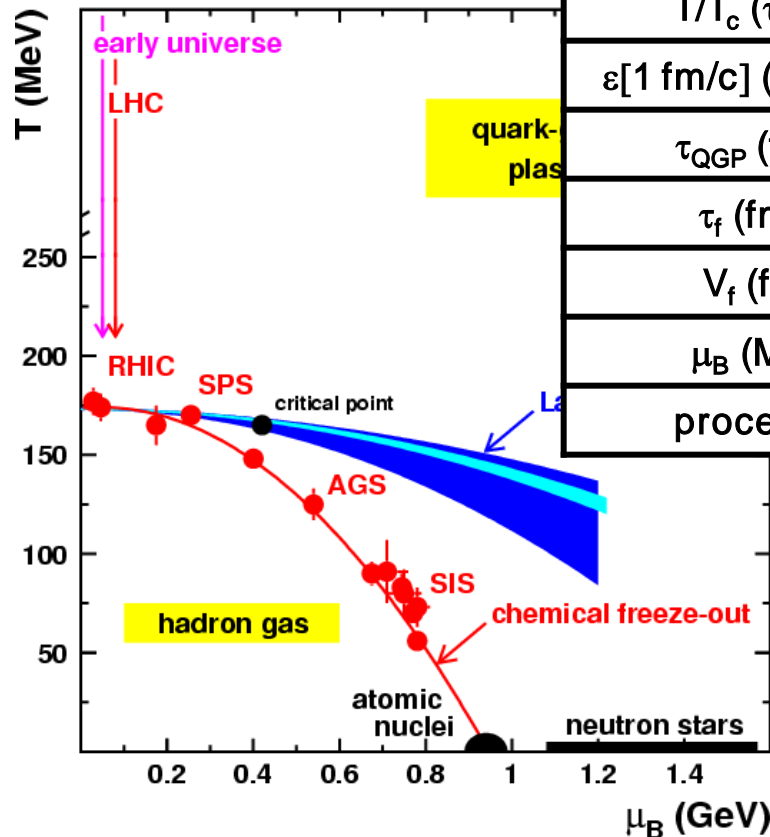

- new environment
- better conditions for studying the QGP
- each collision is a "Little Bang"

The LHC (Large Hadron Collider) @ CERN (European Organization for Nuclear Research)



France

LHC

SPS

Switzerland

8.6 km

Geneva
airport

The LHC in numbers

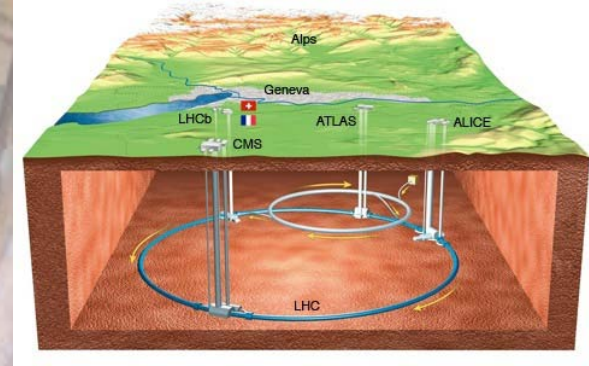

mean depth: 100 meters, circumference: 27 km, 9593 magnets

beam energy: 2.75 TeV Pb, 7 TeV proton (= 99.9999991 % of speed of light)

2808 bunches, 10^{11} protons/bunch, 11245 turn/s, 600 millions collisions/s

4 detectors ₂

LHC detectors

1990-1996 : design
1992-2002 : R&D
2000-2010 : construction
2002-2007 : installation
2002-2009 : commissioning
Dec. 2009 → data taking

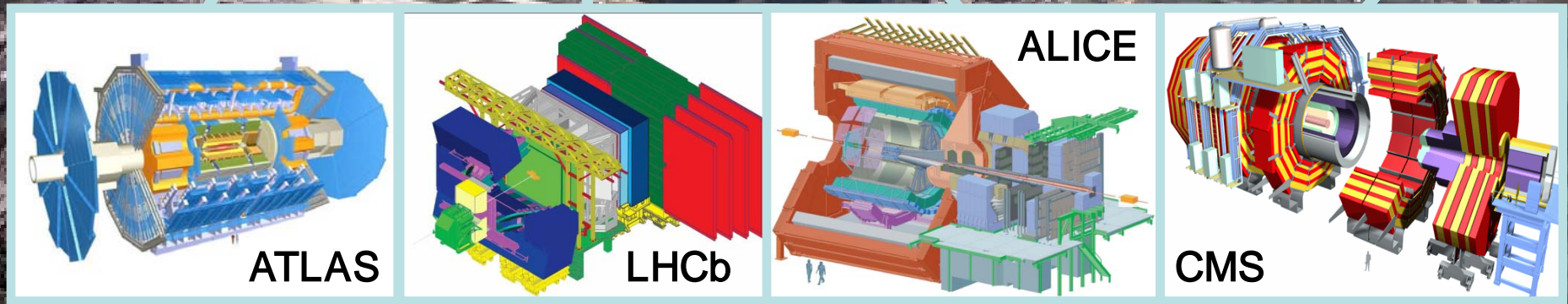

LHC research program (key words): Higgs, supersymmetry, dark matter, dark energy, matter-antimatter imbalance, quark-gluon plasma, extra-dimensions...

ALICE (A Large Ion Collider Experiment)

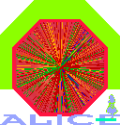

~1000 members
111 institutes
31 countries

7(4) SPS(RHIC) experiments in one
18 sub-detectors
10000 tons
16 x 26 m
150 MCHF

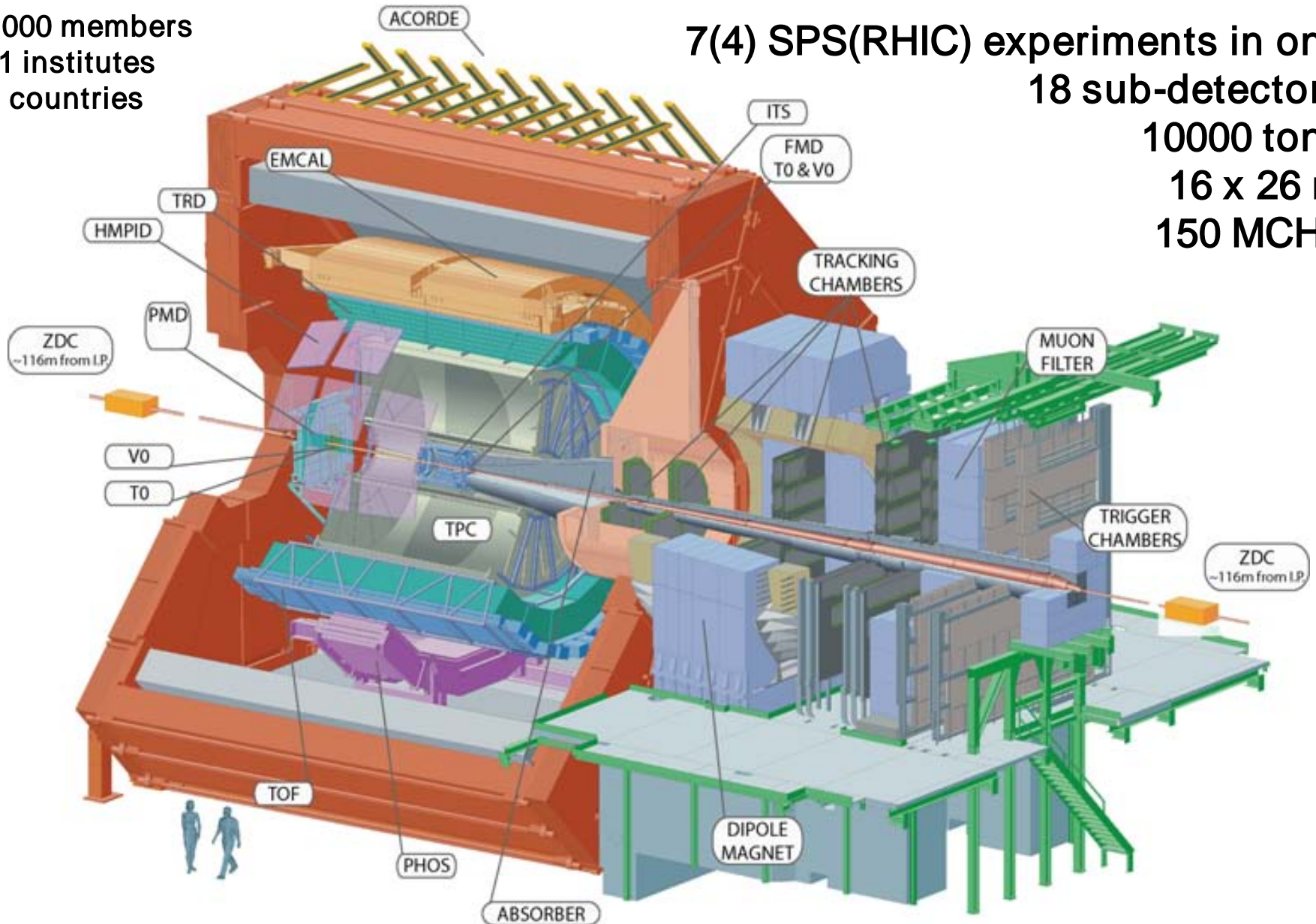

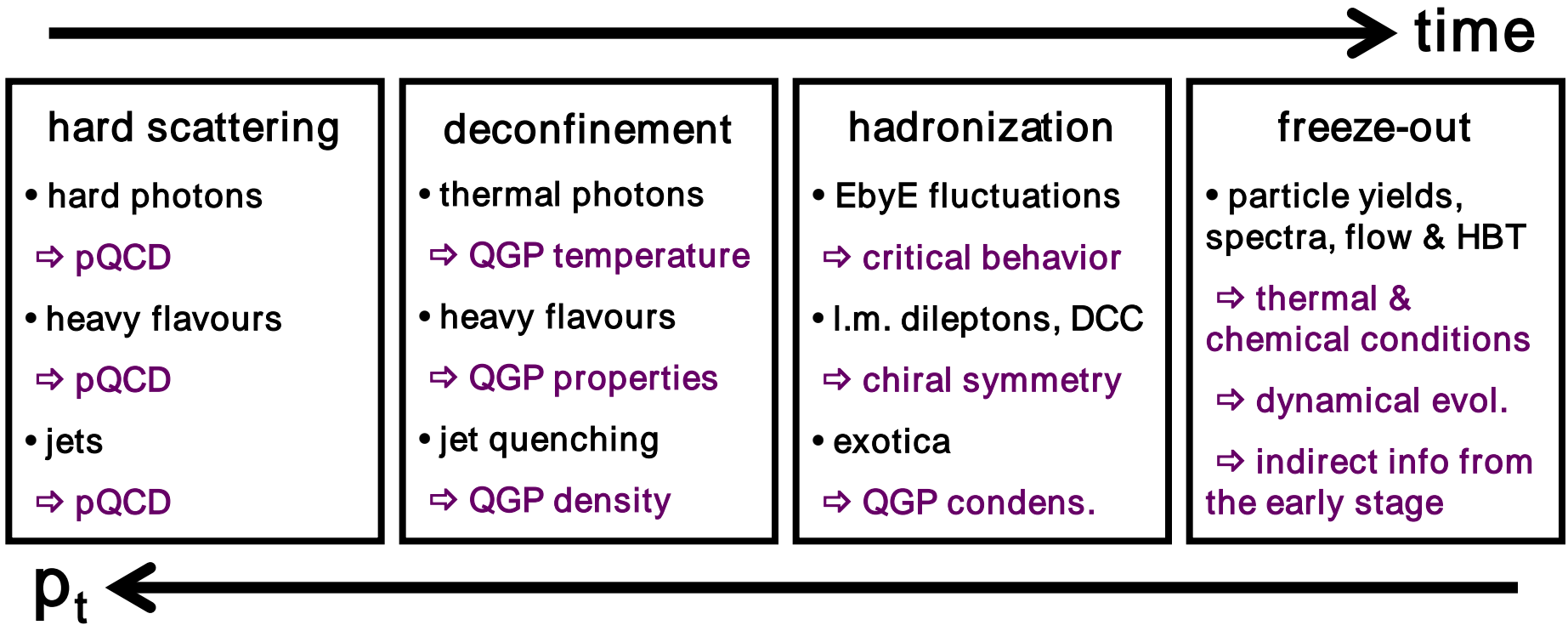
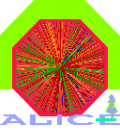

ALICE is designed to explore a broad p_t range and to correlate most of the signals

large acceptance & granularity, selective triggers, good tracking capabilities, wide momentum coverage, good secondary vertex reconstruction, hadron, lepton & photon id.

soft sector: observables & expected performances comparable to that of RHIC
hard sector: new observables, new analyses

Expected track density

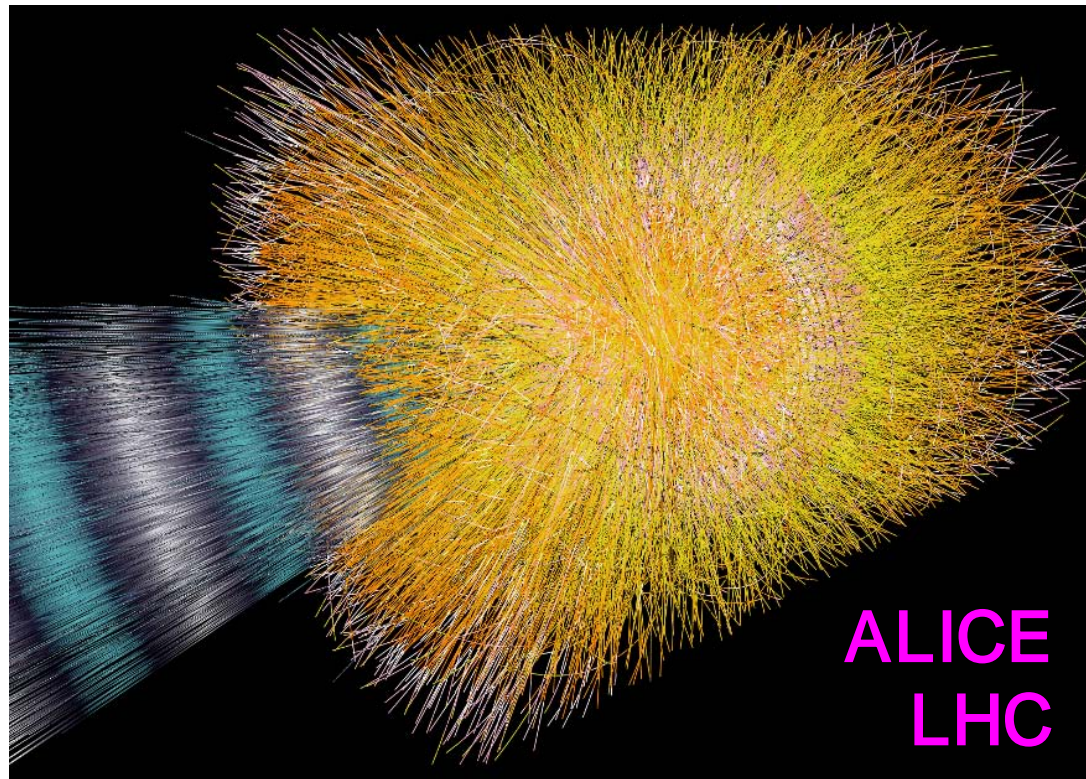
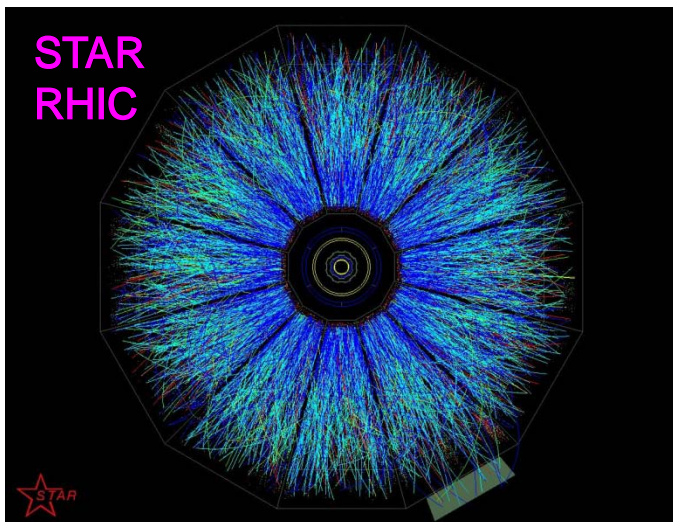
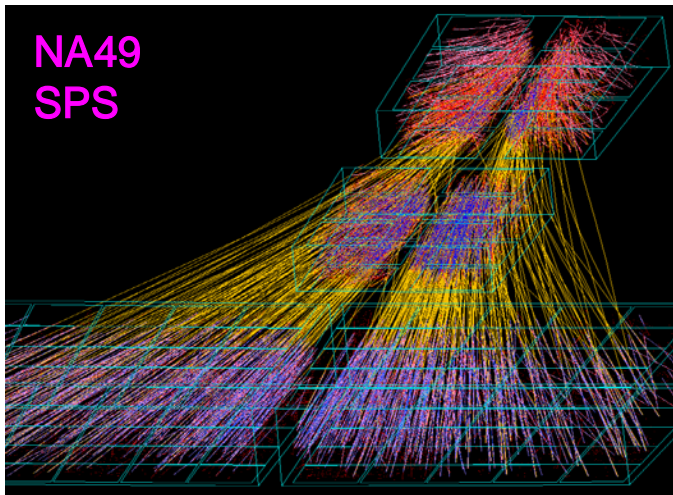

Particle identification with ALICE

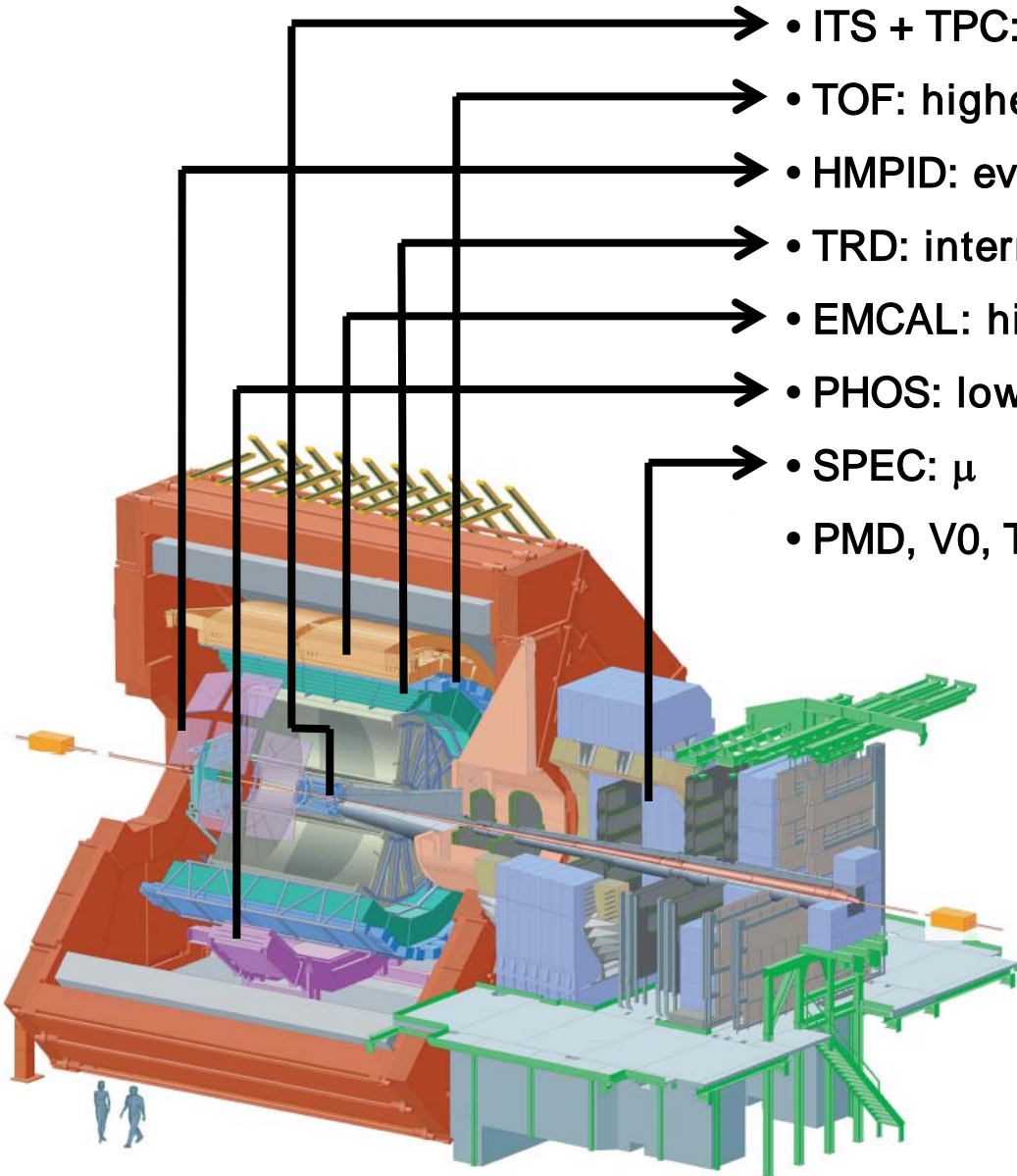
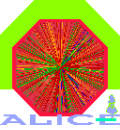

- • ITS + TPC: low & intermediate p_t e, π, K, p
- • TOF: higher p_t π, K, p
- • HMPID: even higher p_t π, K, p
- • TRD: intermediate p_t e
- • EMCAL: high p_t γ, e, π^0
- • PHOS: lower p_t γ, e, π^0
- • SPEC: μ
- • PMD, V0, T0, FMD, ZDC: trigger, vertex, lum., γ, π^0 ...

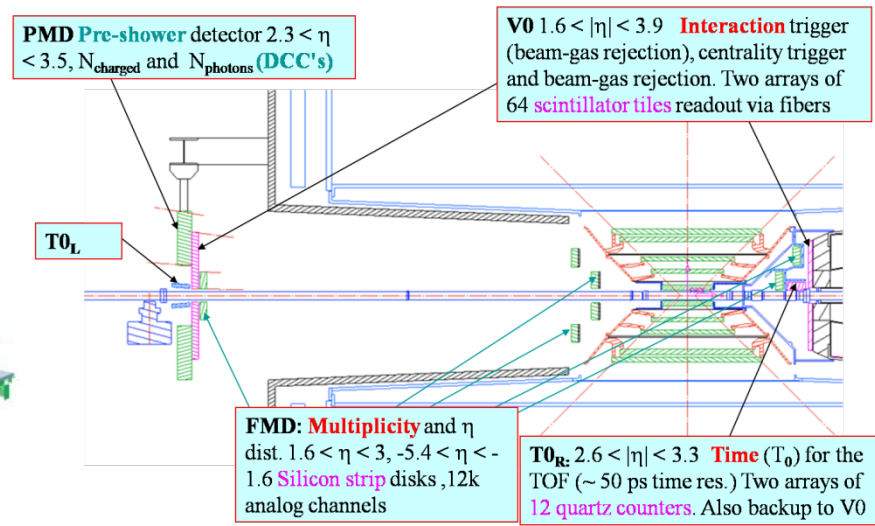

Resonances

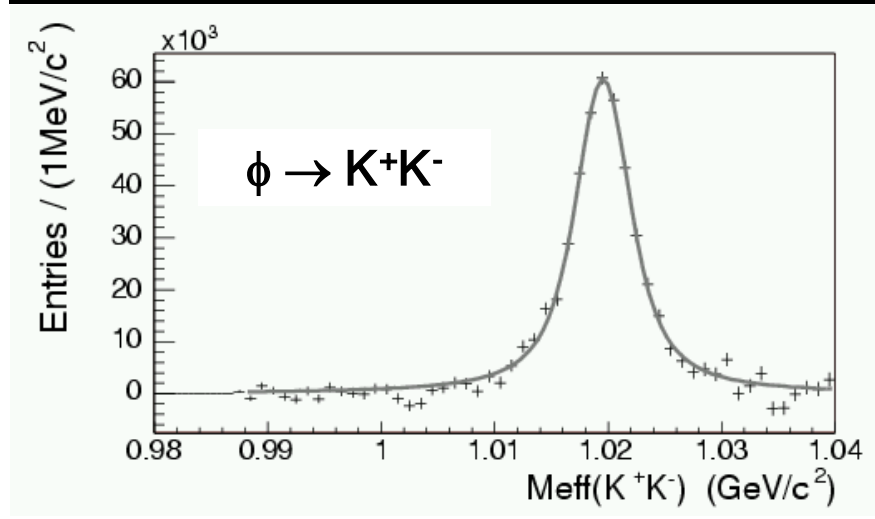
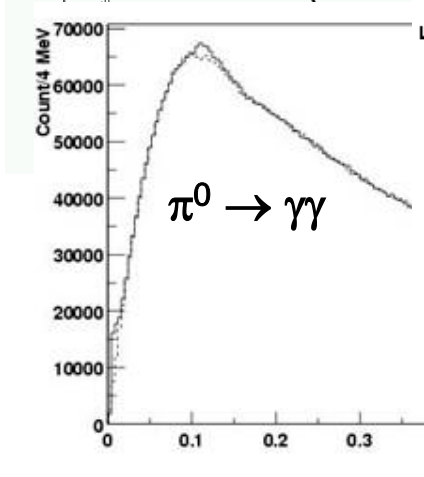
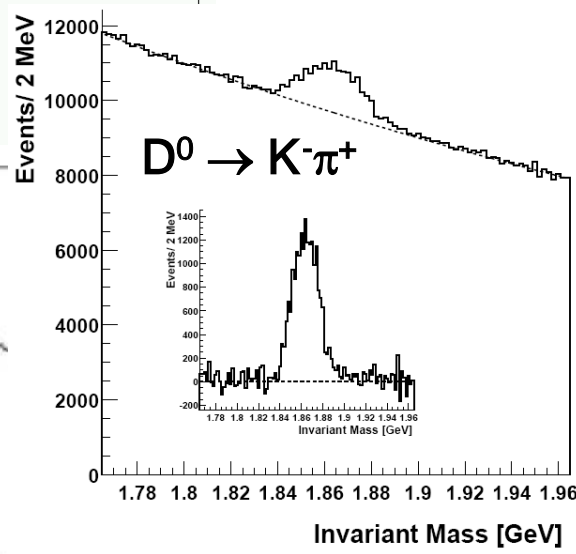
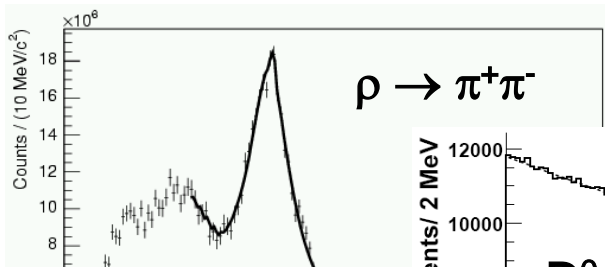
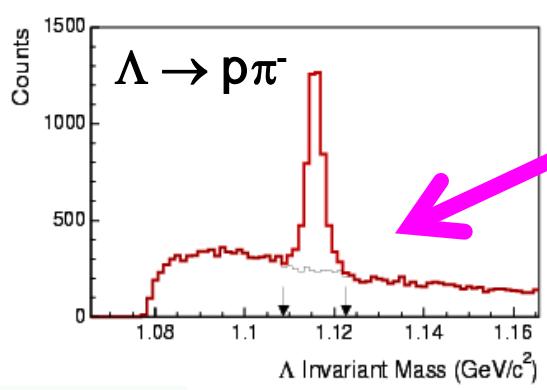
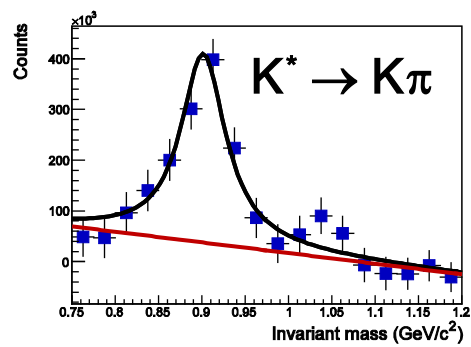
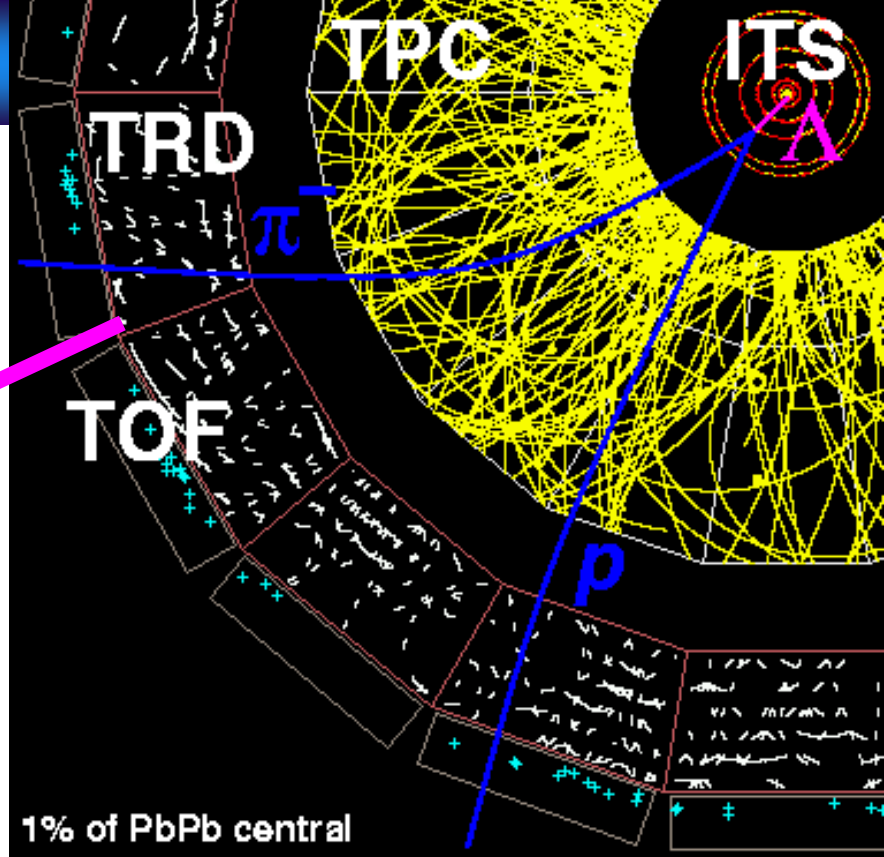

etc...

(di-)leptons

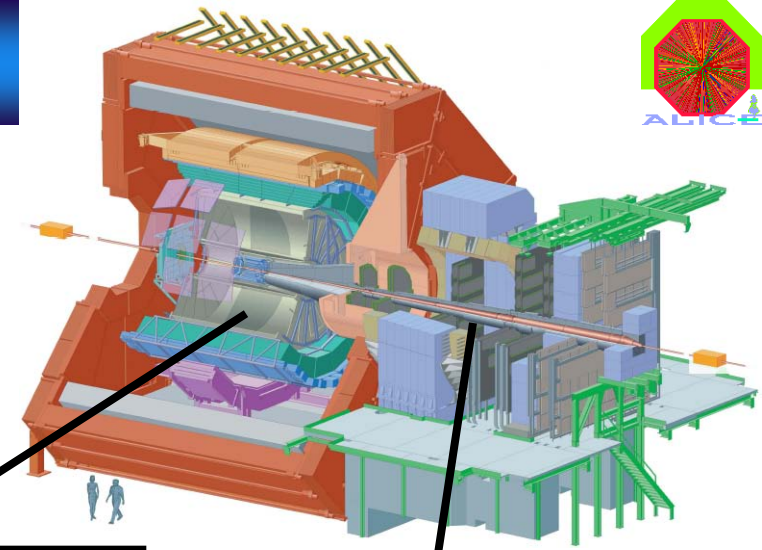
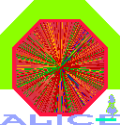

7.5 · 10⁷ central (10%) PbPb evts

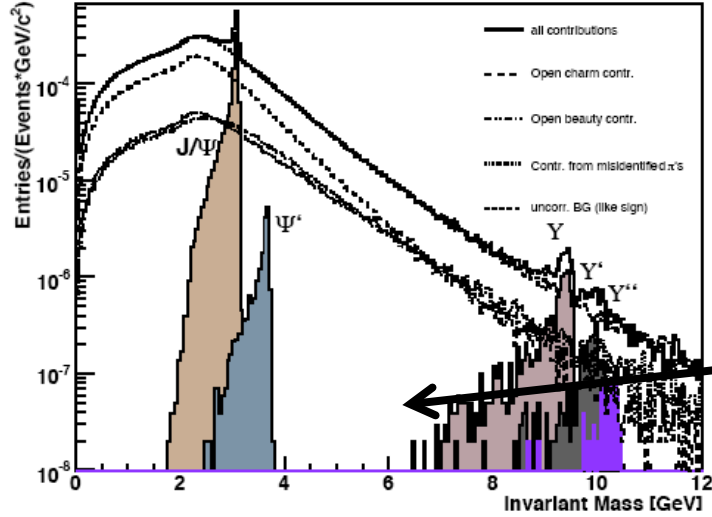

$\rho, \omega, \phi, J/\psi, \psi', \Upsilon, \Upsilon', \Upsilon'', Z^0, W^\pm, \text{charm, bottom} \rightarrow e^+e^-$

$\rho, \omega, \phi, J/\psi, \psi', \Upsilon, \Upsilon', \Upsilon'', Z^0, W^\pm, \text{charm, bottom} \rightarrow \mu^+\mu^-$

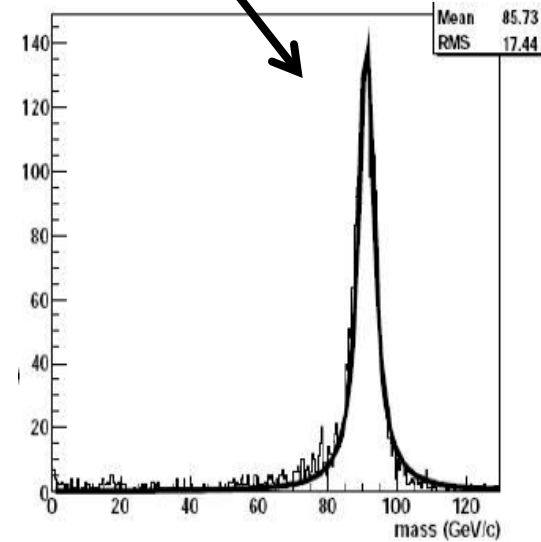
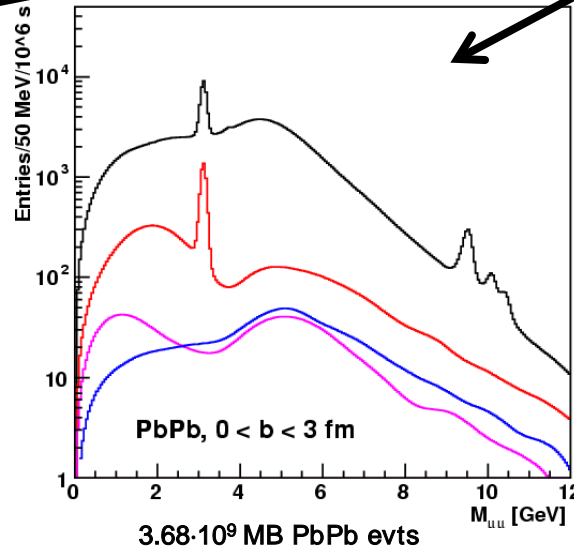
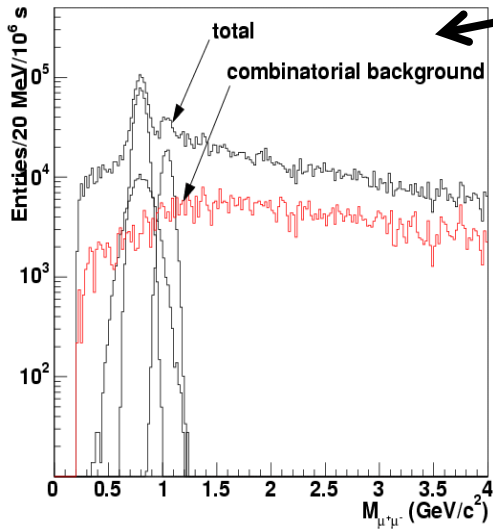

Selected expected performances

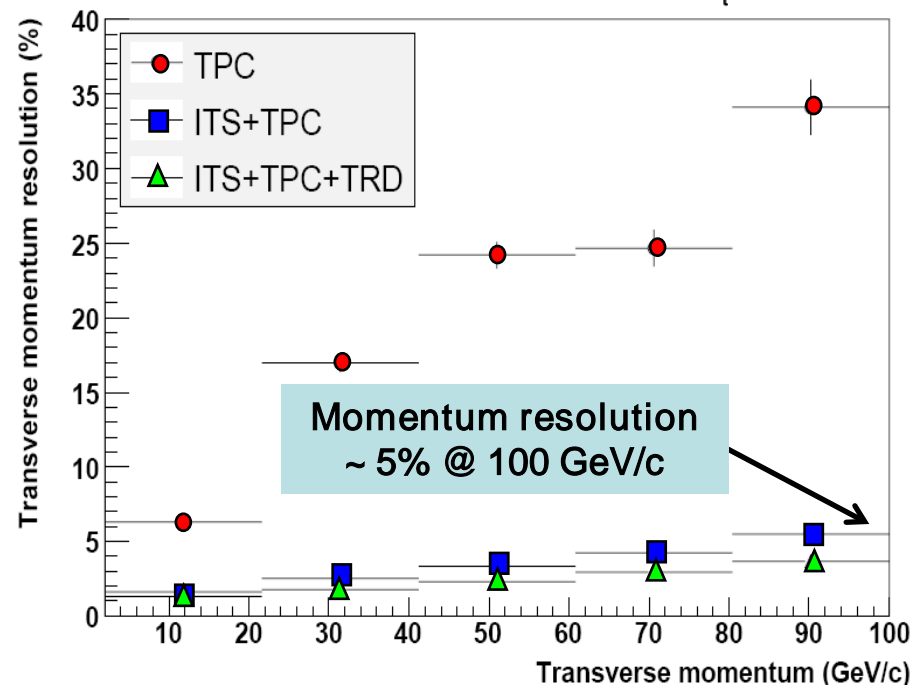
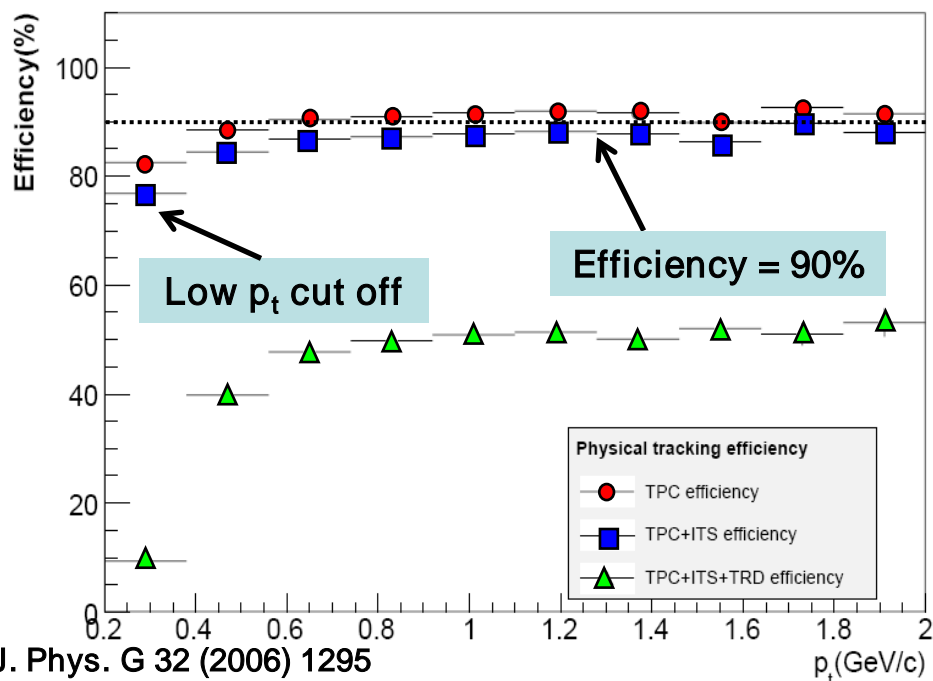
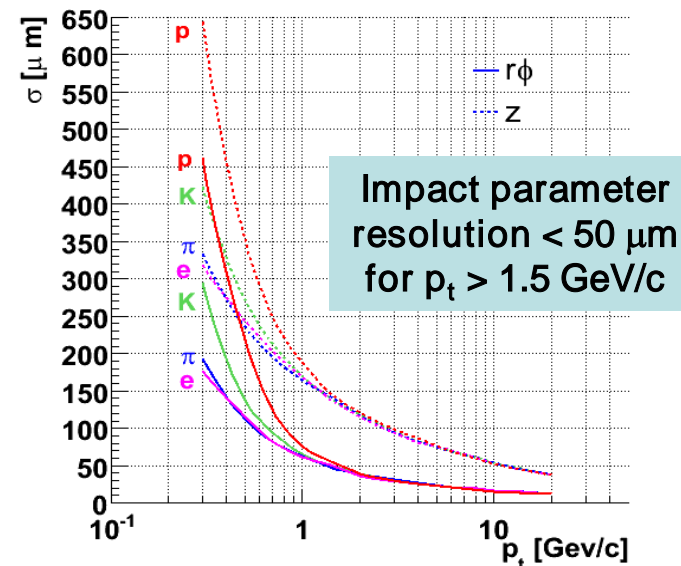
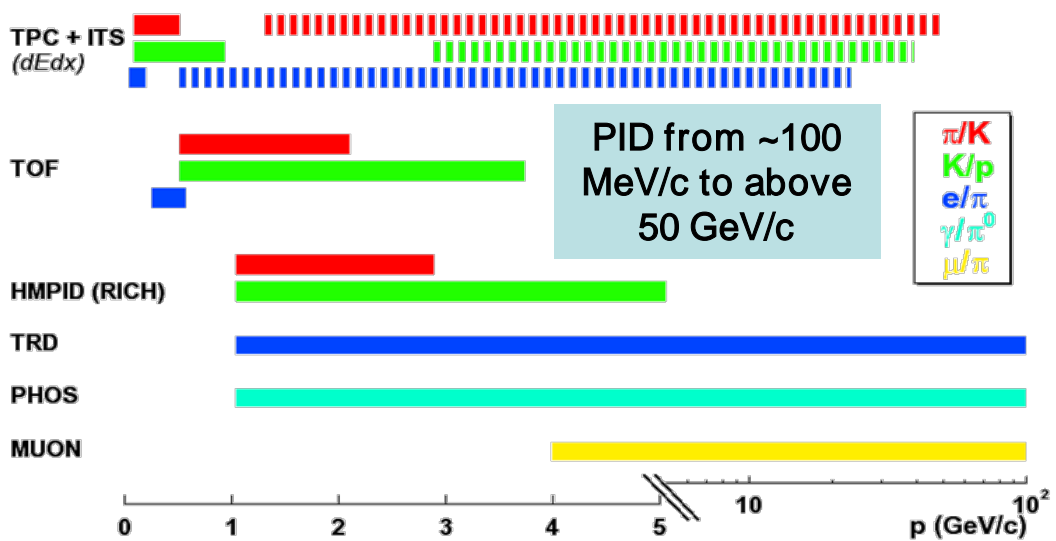
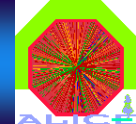

Example of physics performance: Expected statistics in the heavy flavour sector

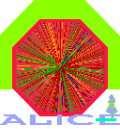

1 LHC year = 7 months pp (10^7 s, $3 \cdot 10^{30} \text{cm}^{-2} \text{s}^{-1}$) + 1 month AA (10^6 s, $5 \cdot 10^{26} \text{cm}^{-2} \text{s}^{-1}$)

		muon channel				
		J/ψ	ψ'	Υ	Υ'	Υ''
PbPb MB 5.5 TeV $3.68 \cdot 10^9$ evts	S ($\times 10^3$)	681.4	18.92	6.33	1.8	1.02
	S/B	0.33	0.02	2.46	1.03	0.74
	S/ $\sqrt{S+B}$	413	19.53	67.14	30.19	20.85
pp 14 TeV $2.1 \cdot 10^{12}$ evts	S ($\times 10^3$)	4670	122	44.7	11.4	6.9
	S/B	12.6	0.55	5.8	1.9	1.3
	S/ $\sqrt{S+B}$	2081	209	195	86	62

		D ⁰ → πk
PbPb 5% 5.5 TeV 10^7 evts	S ($\times 10^3$)	13
	S/B	0.11
	S/ $\sqrt{S+B}$	37
pp 14 TeV 10^9 evts	S ($\times 10^3$)	21
	S/B	0.5
	S/ $\sqrt{S+B}$	84

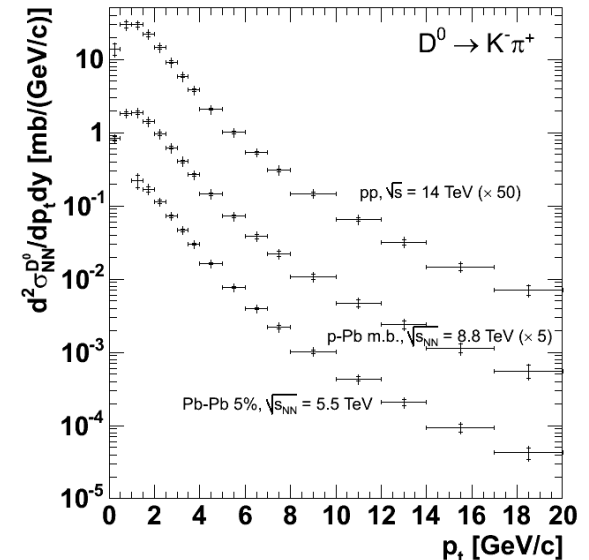
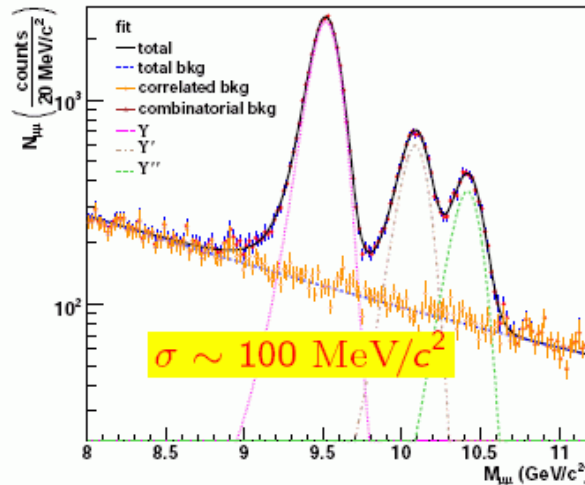
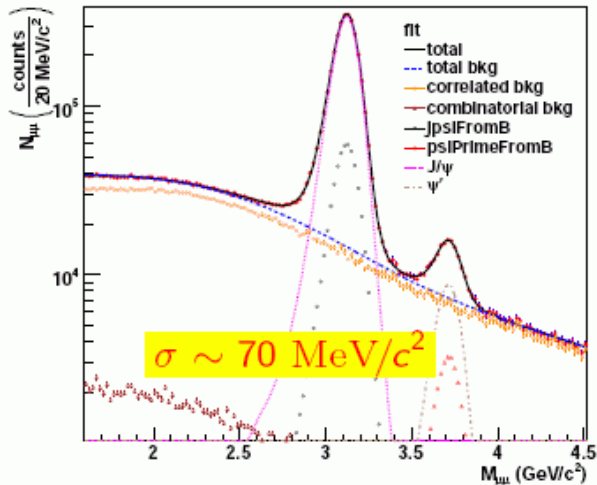

Many more channels e.g. D*, Λ_c, c, b → lepton+X, etc

direct calibration of jet quenching

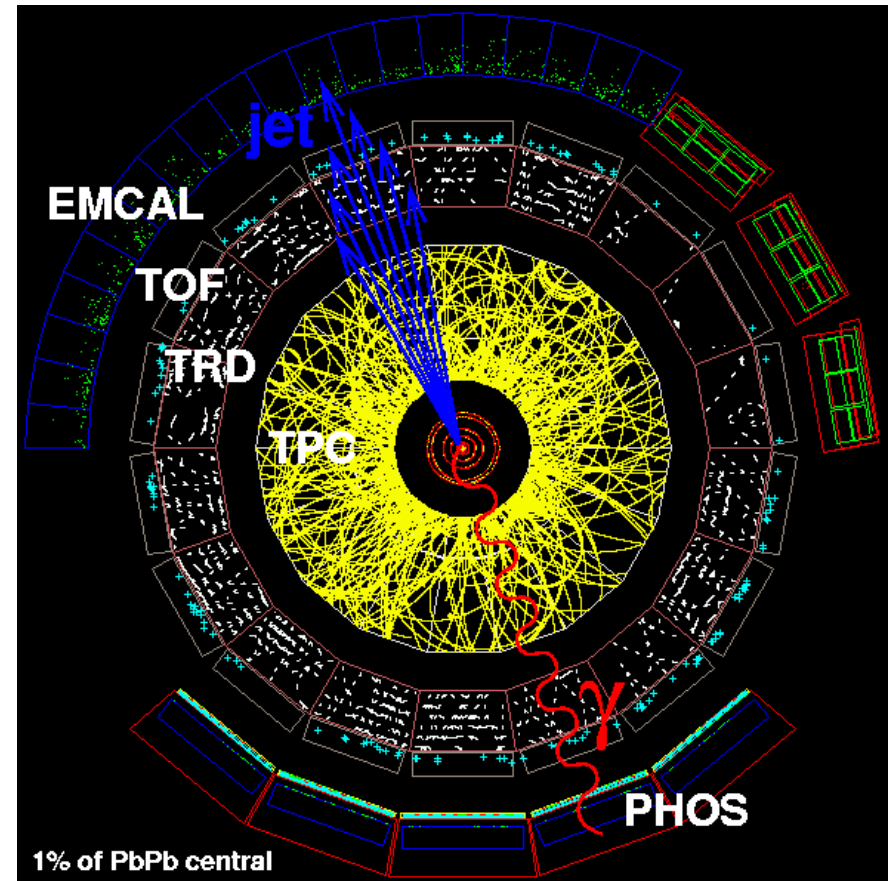
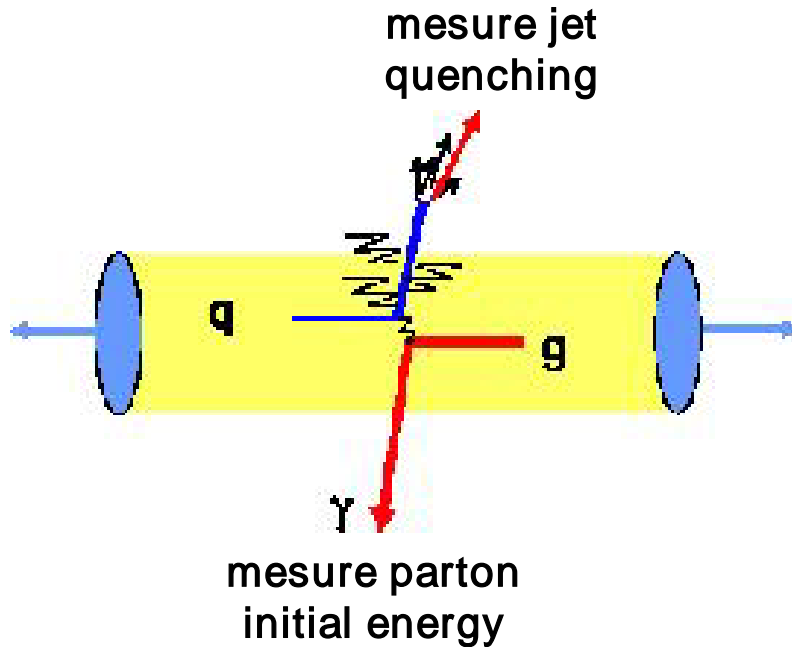

combination of PHOS, EMCAL, particle tracking & Id. allows to get jet trigger, energy loss, particle composition, transverse structure & fragmentation function down to low p_t

ALICE from first design to reality

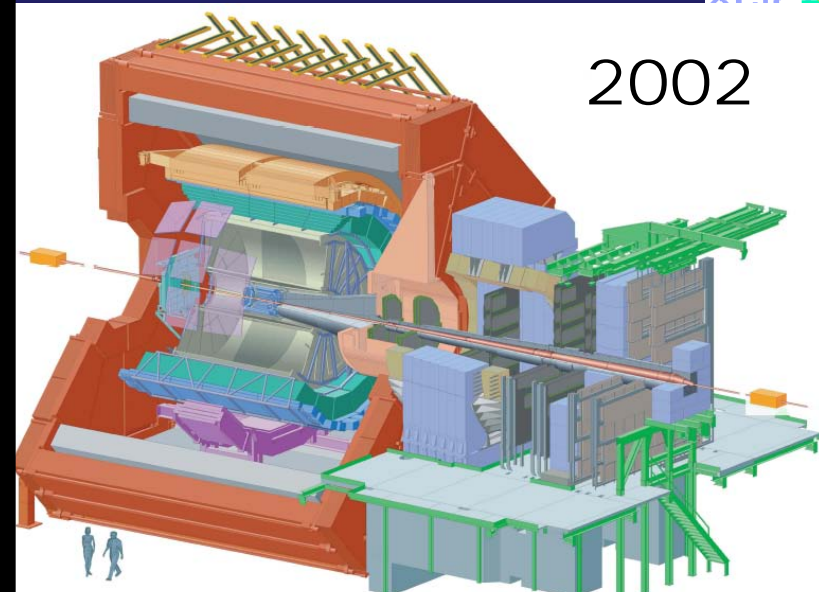
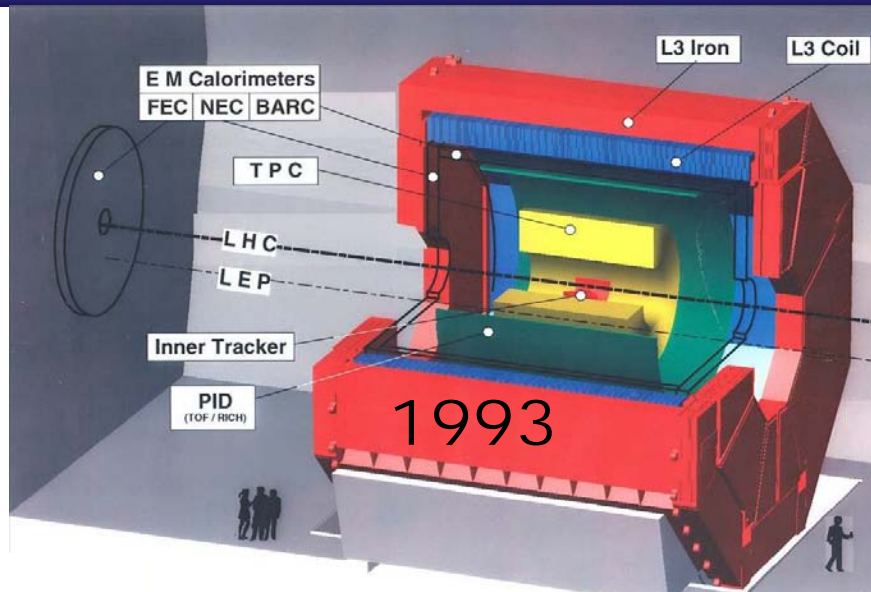
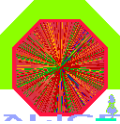

TPC (central piece of ALICE)

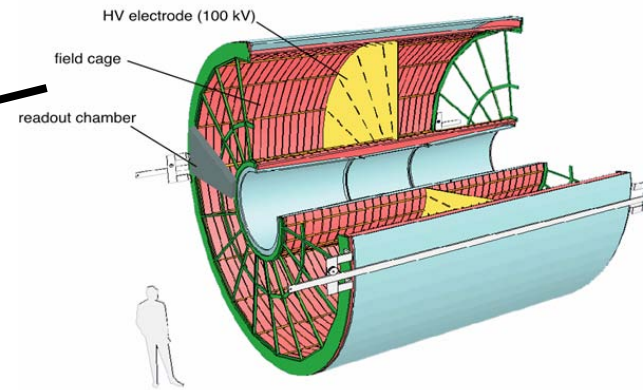
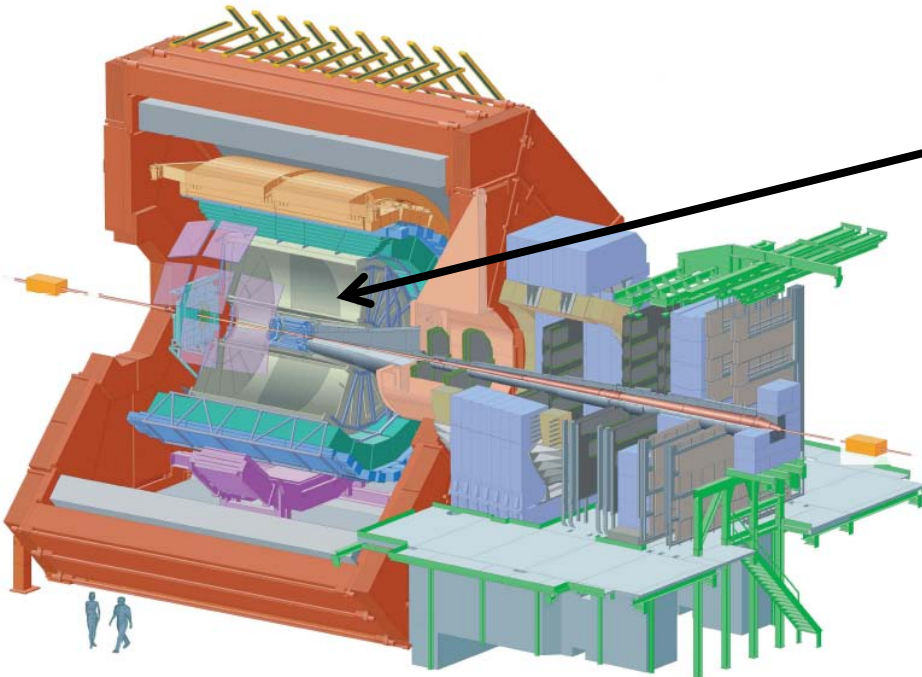
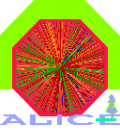

- the biggest in the world
- 510 x 560 cm, 88 m³, 10 tons
- 570 k channels, 80 MB/evt
- 5 years of const. & assembly



Installation of the TPC (jan. 2007)

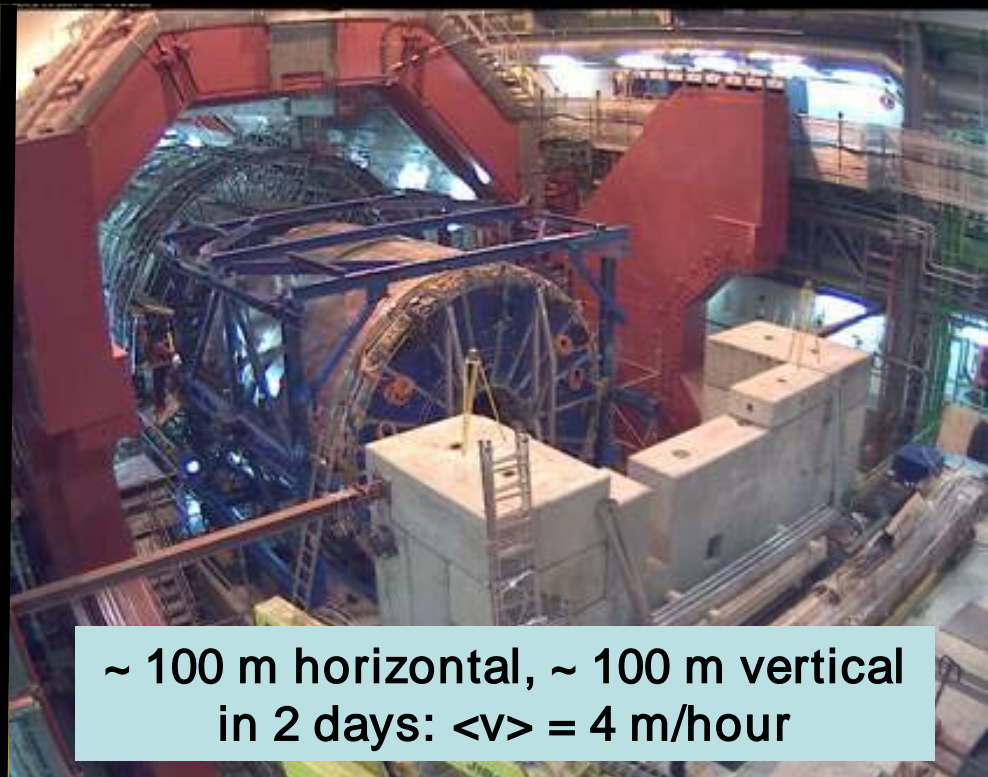
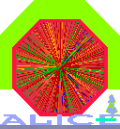

~ 100 m horizontal, ~ 100 m vertical
in 2 days: $\langle v \rangle = 4 \text{ m/hour}$

ITS (Inner Tracking System)

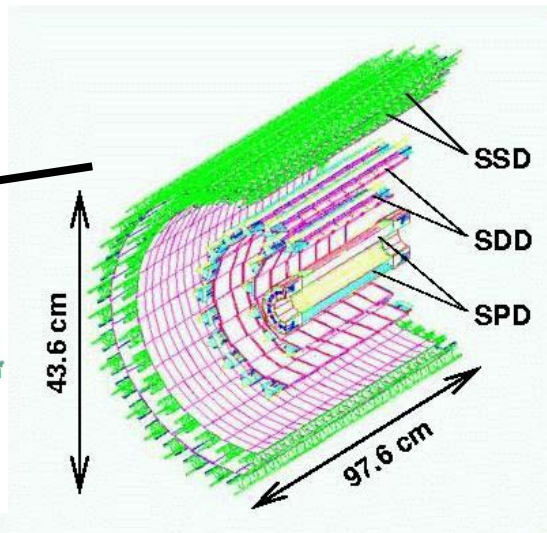
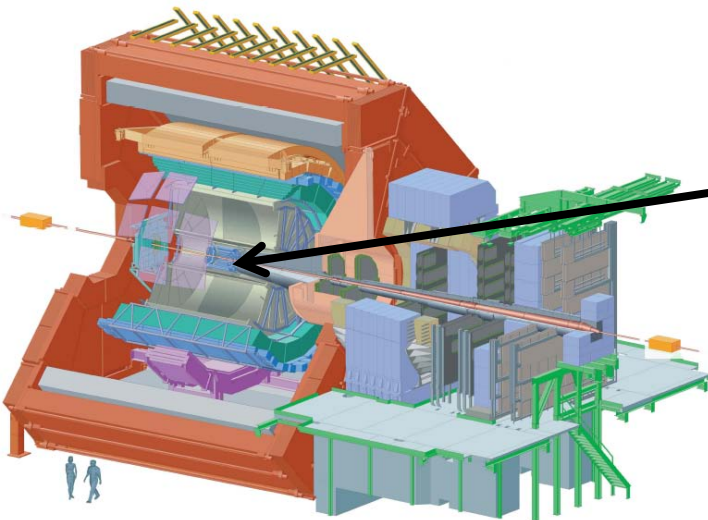
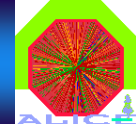

type	surface	# channels
SPD (pixel)	0.2 m ²	9.8 M
SDD (drift)	1.3 m ²	1.33 k
SSD (strip)	4.9 m ²	2.6 M

should be able to identify
~90 particles/cm²/collision
every 100 ns

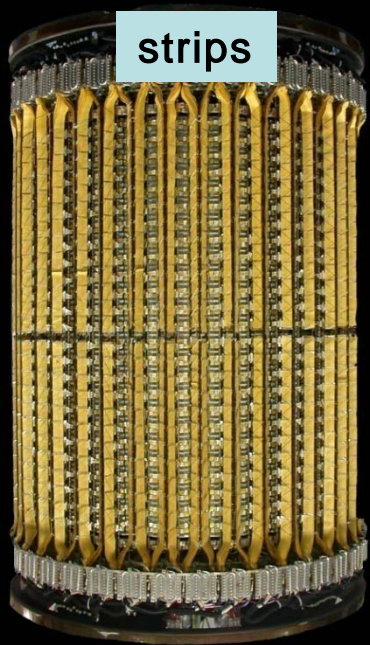

strips

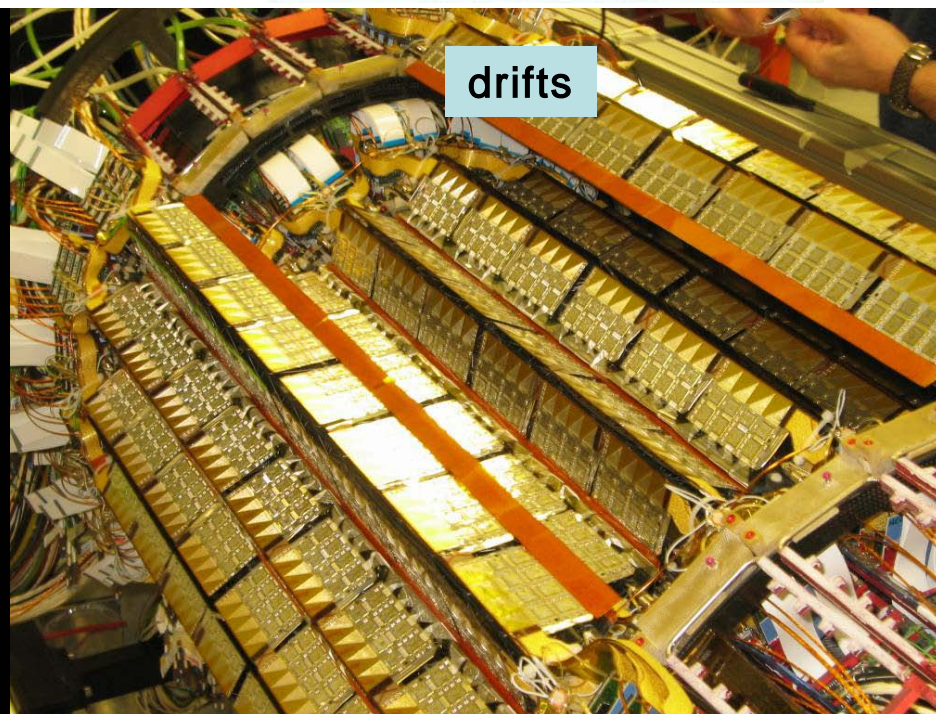

drifts

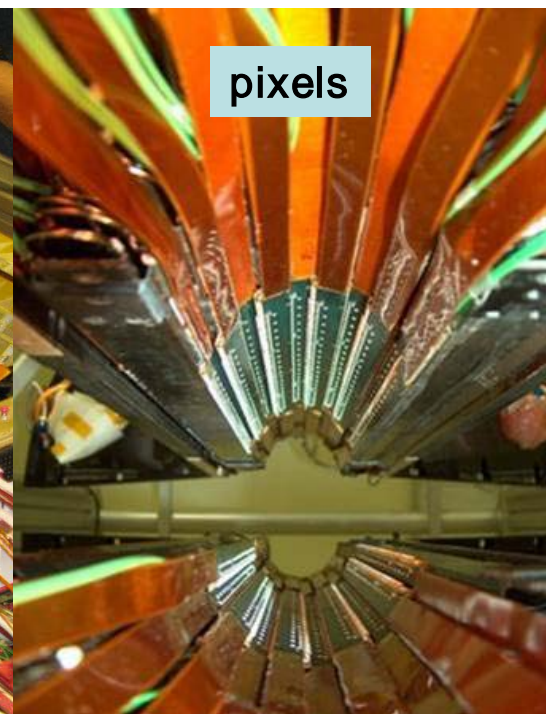

pixels

Installation of the ITS

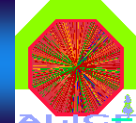

mounting

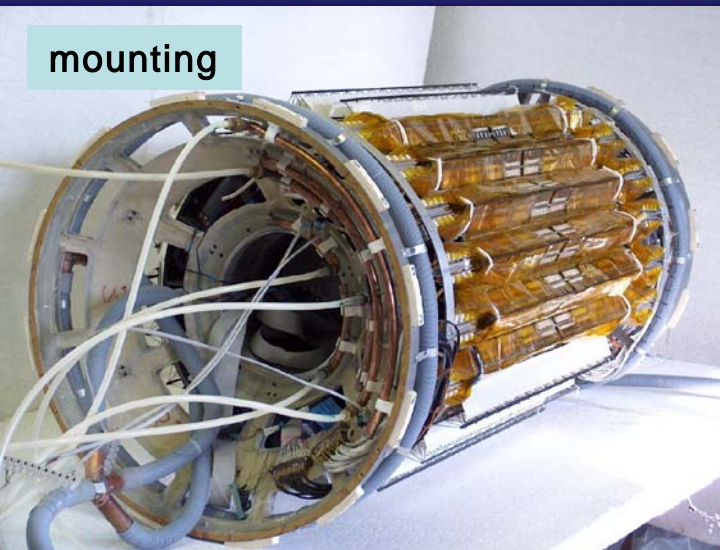

transport

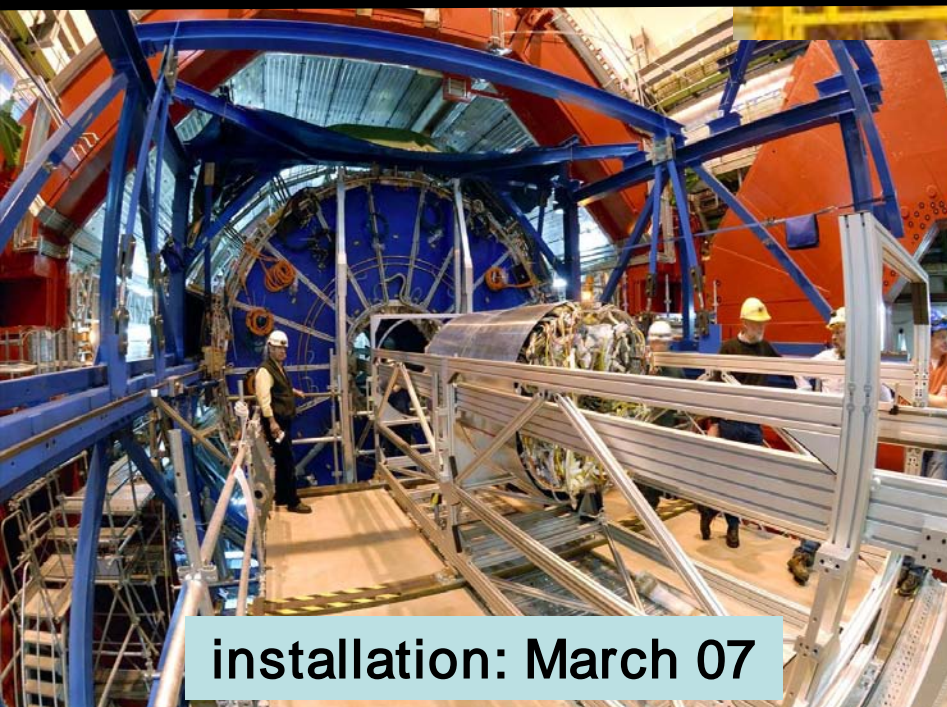

installation: March 07

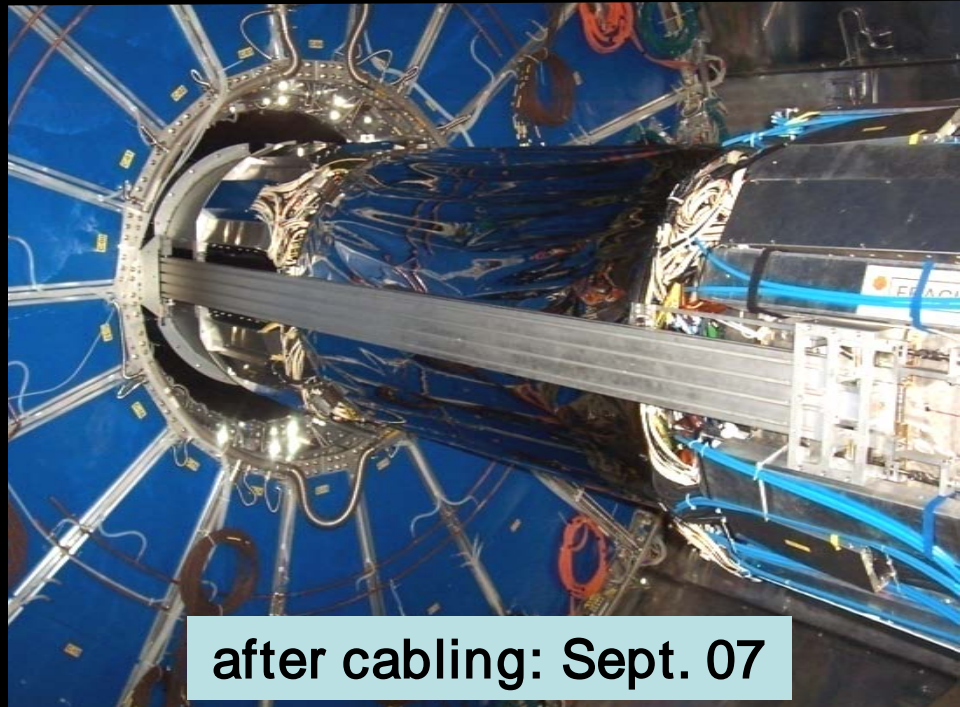

after cabling: Sept. 07

A complex mechanical structure



front absorber of the muon spectrometer

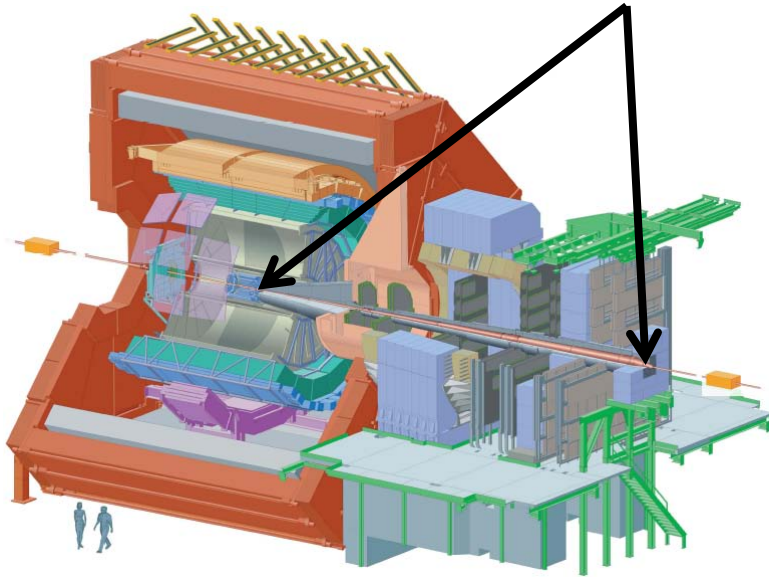

100 tons, 18 m, W, Pb, Fe, graphite, concrete...

concrete: France, engineering & supervision: CERN,
design: Russia



Polyethylene:
Italy



Tungstene:
China



Lead: UK



Support: Italy



Graphite: Inde



Steel: Finland



Aluminum: Armenia



Steel: India

Muon spectrometer dipole (I)

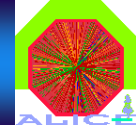

the biggest in the world, 0.7 T, 3 Tm, 4 MW, 800 tons

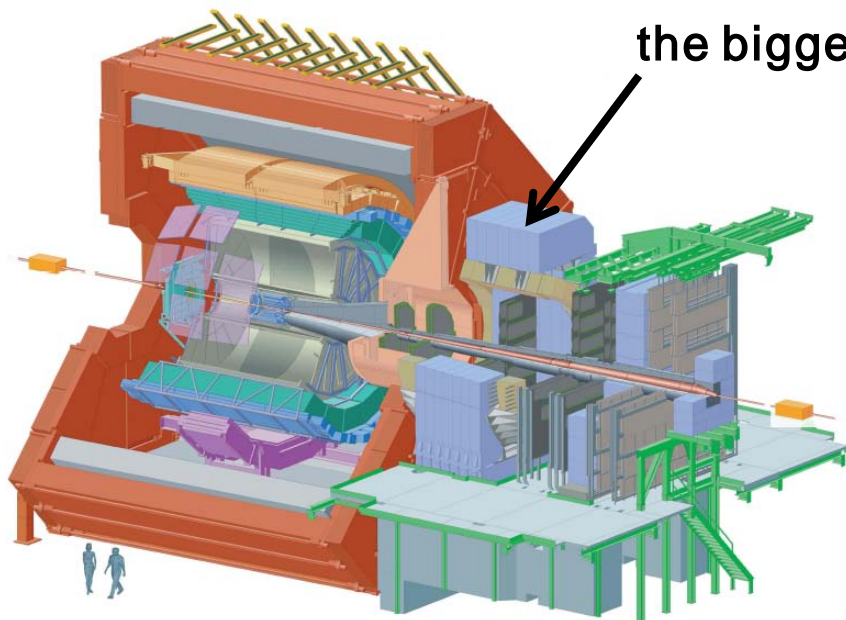

Sept. 2003: arrival of coils at CERN



fitting barely under the bridge

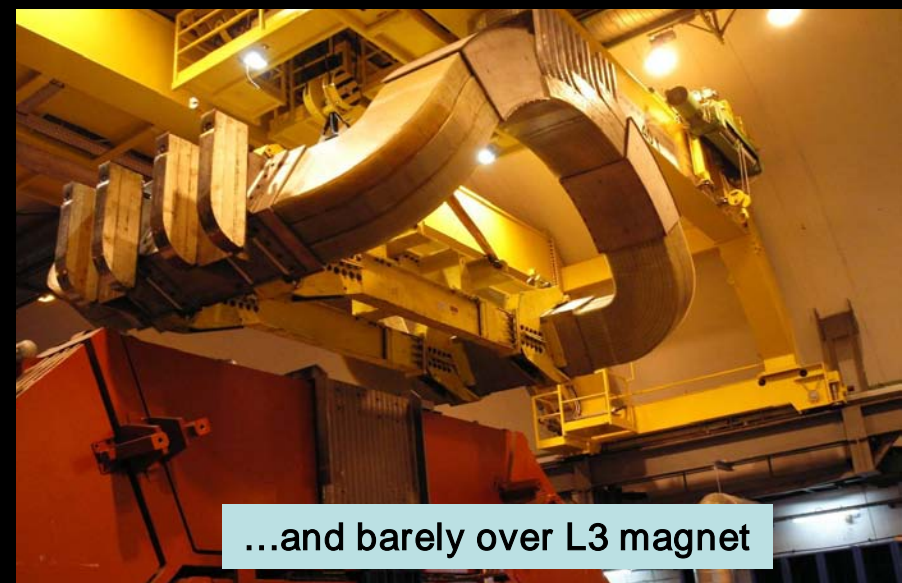

...and barely over L3 magnet

Muon spectrometer dipole (II)



2002: yoke test assembly in Dubna



2003: transport Dubna-CERN
delayed by 10 months



2004: test assembly
in front of L3

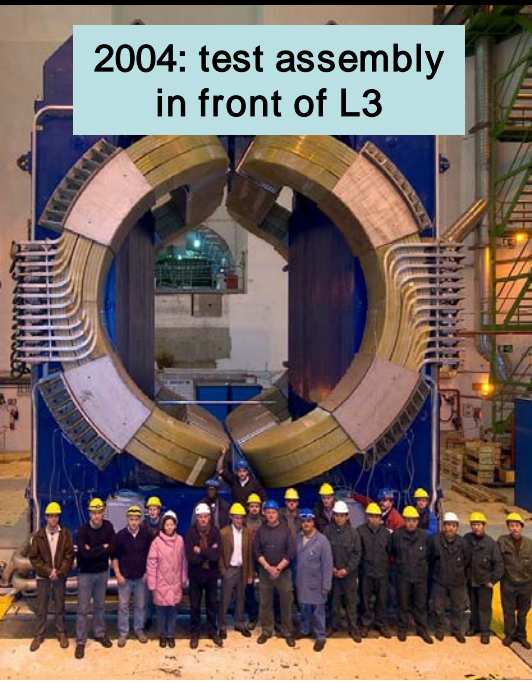

March 2004: closure
of L3 back doors



2005: final assembly
behind L3

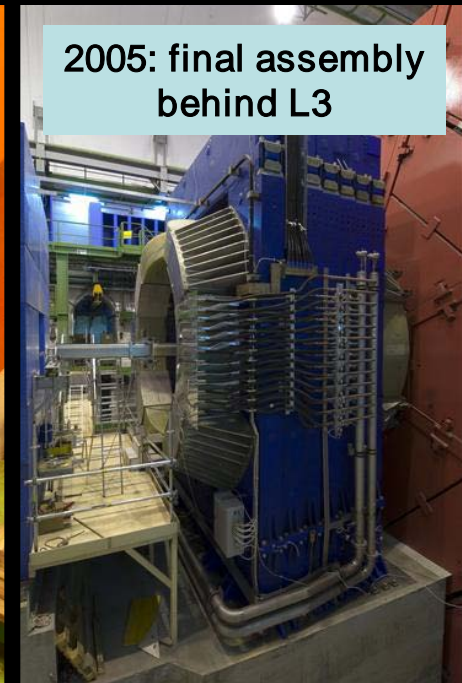

Muon spectrometer installed (spring 2008)

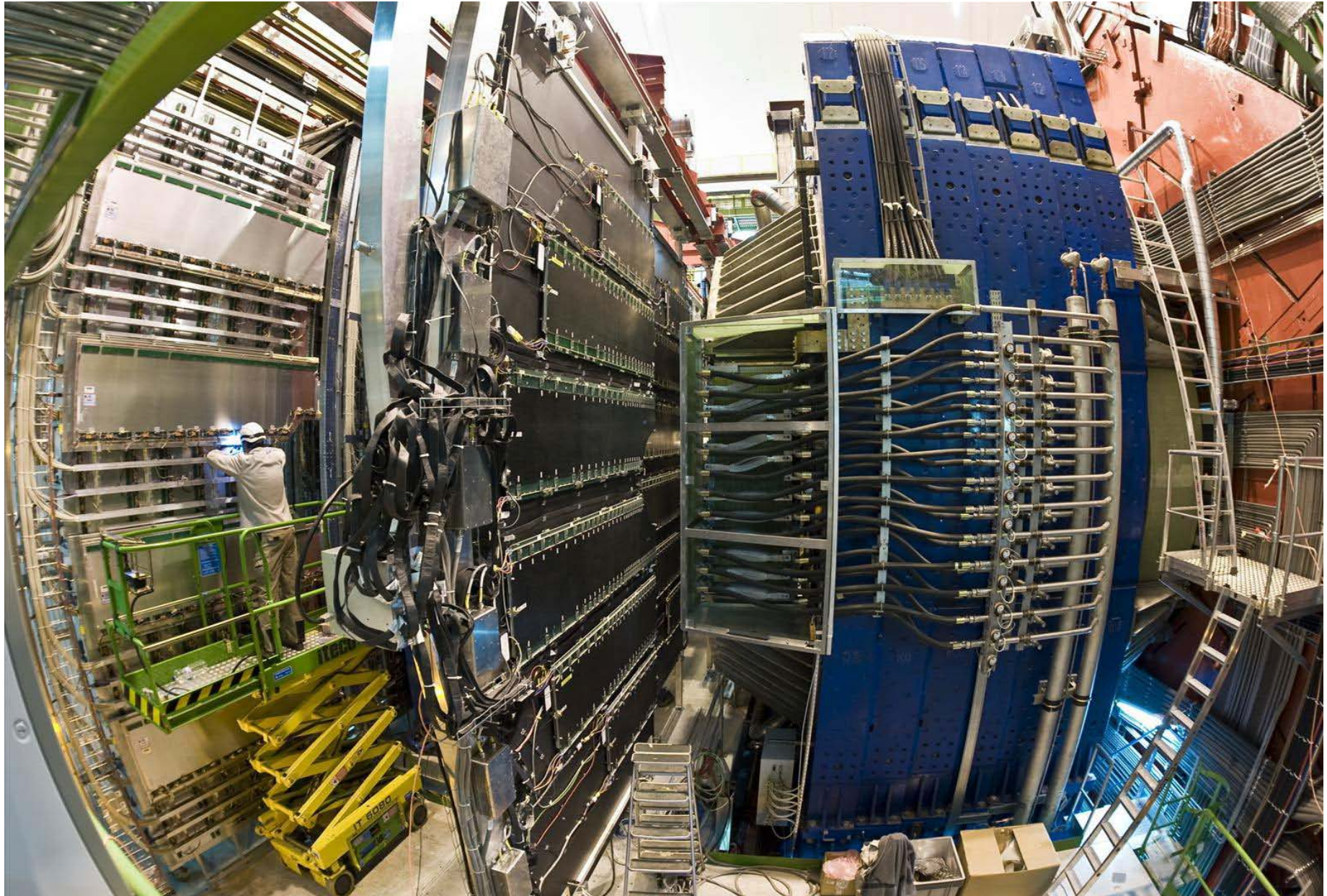
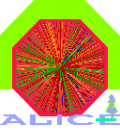

Central barrel detectors installed in 2008

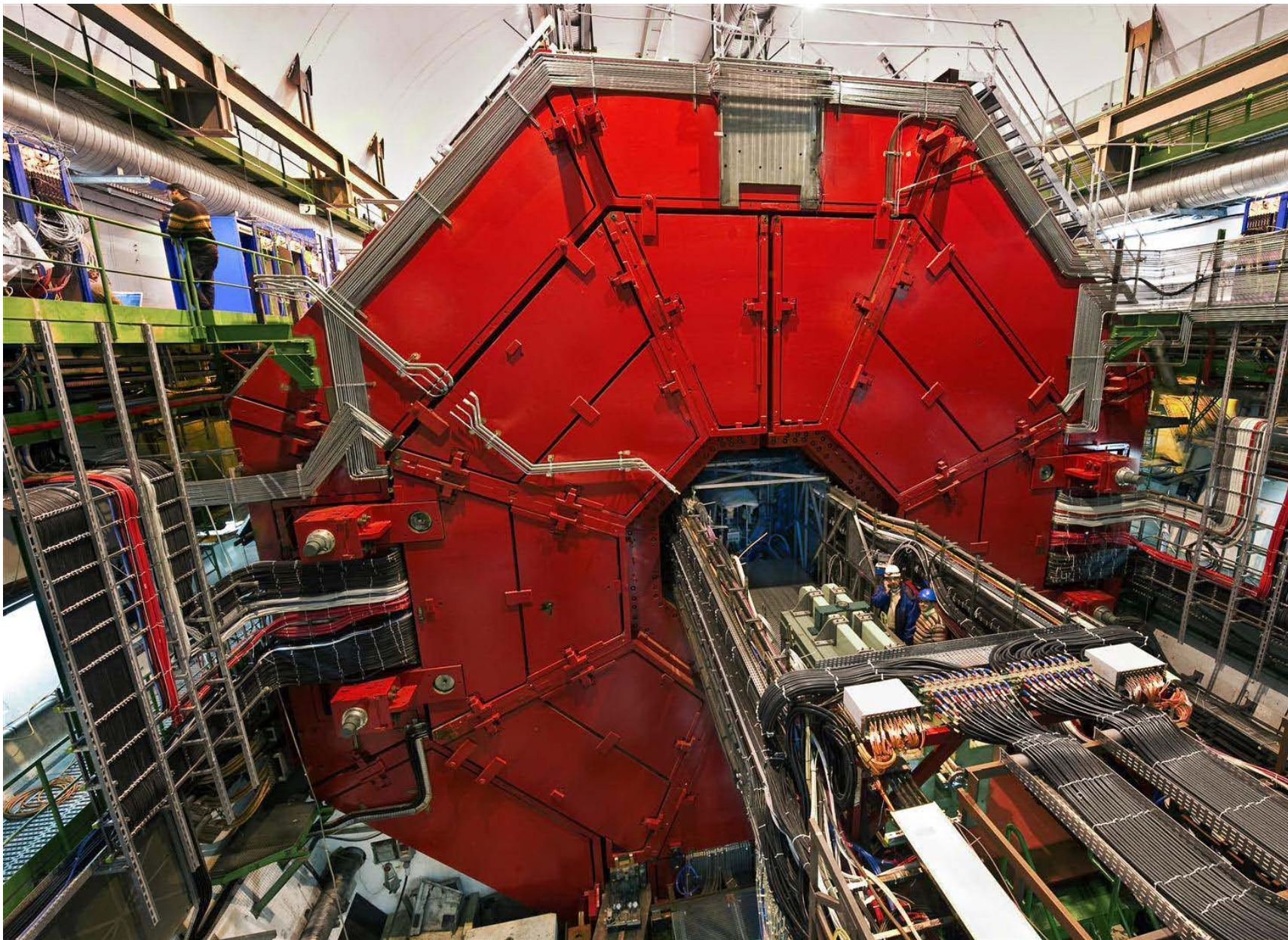

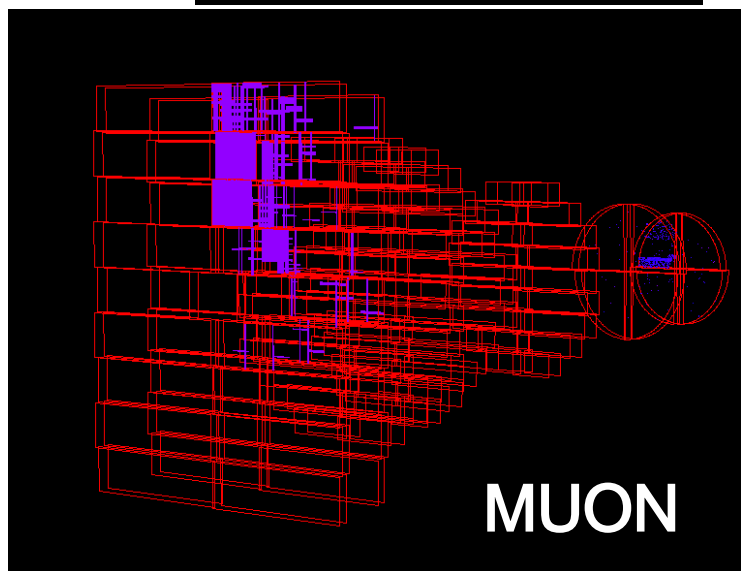
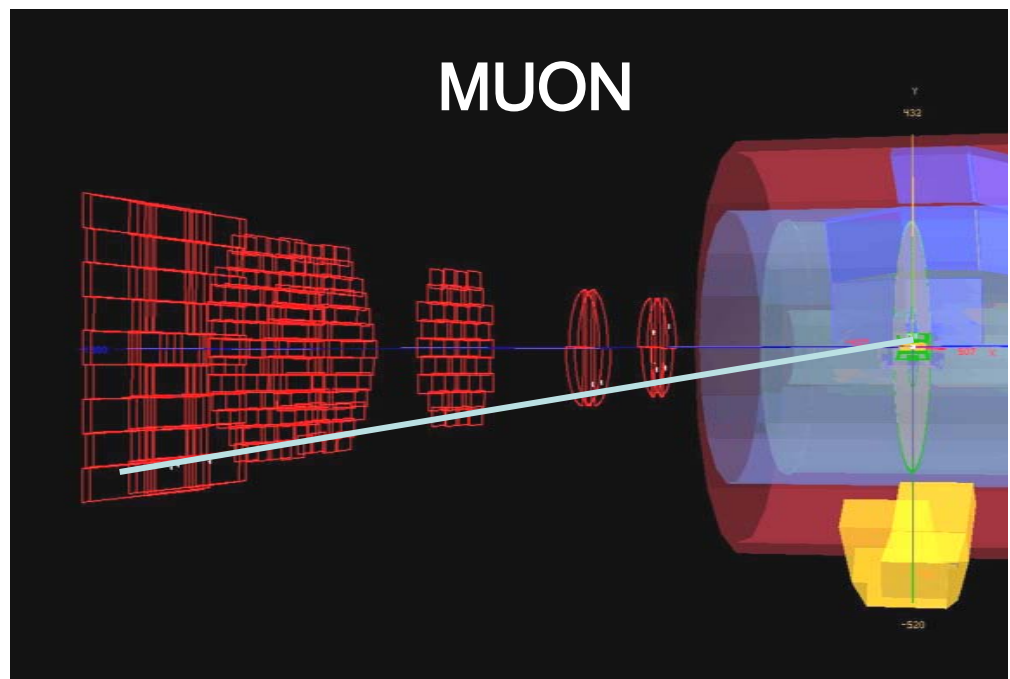
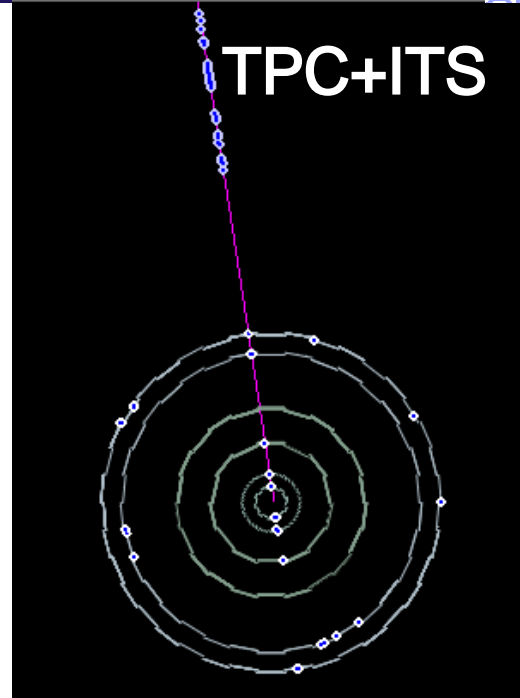
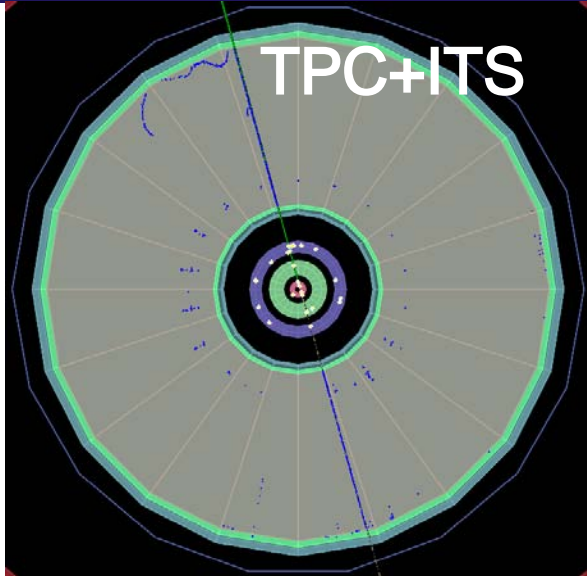
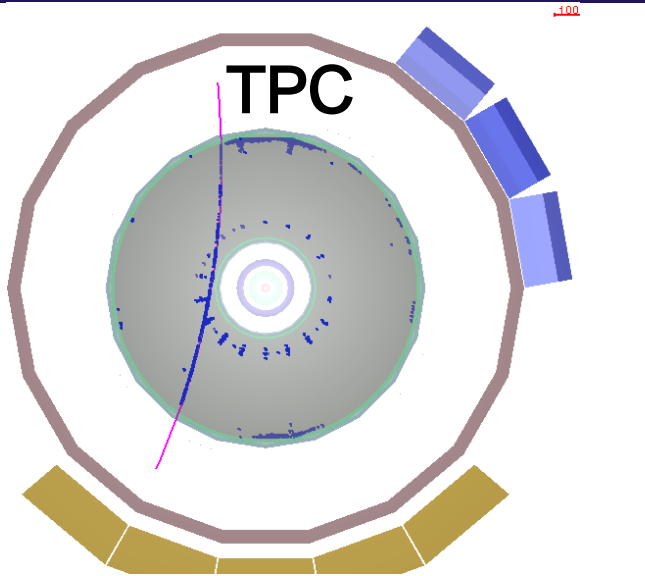
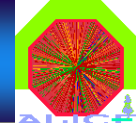

September 10th 2008: first beams

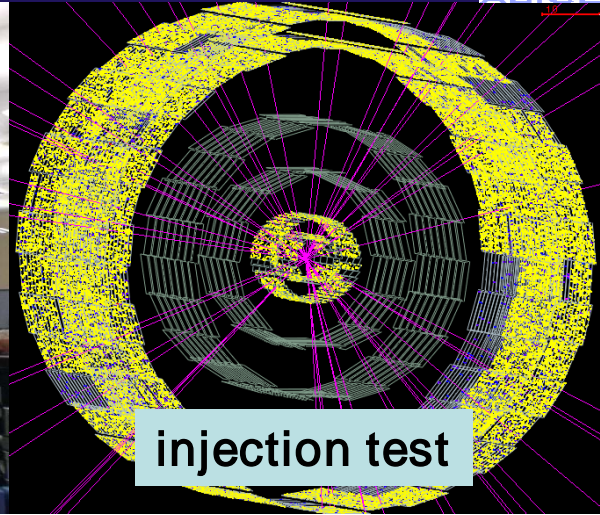
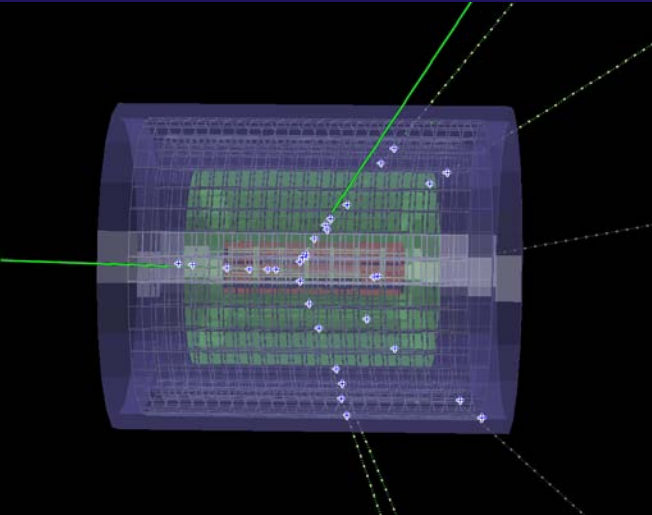

beam-gas collision in ITS

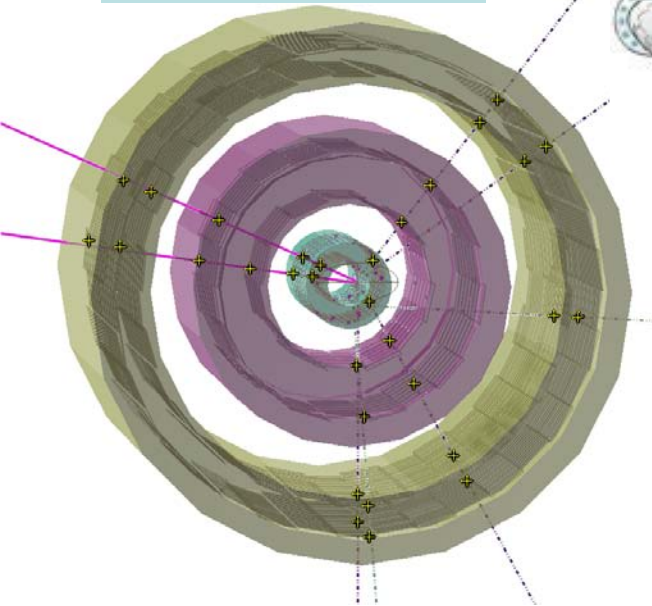

beams in V0s

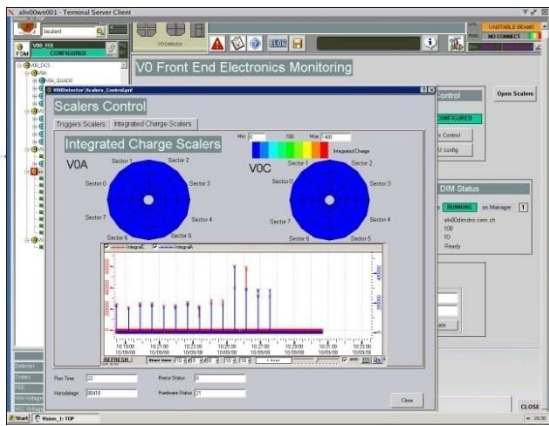
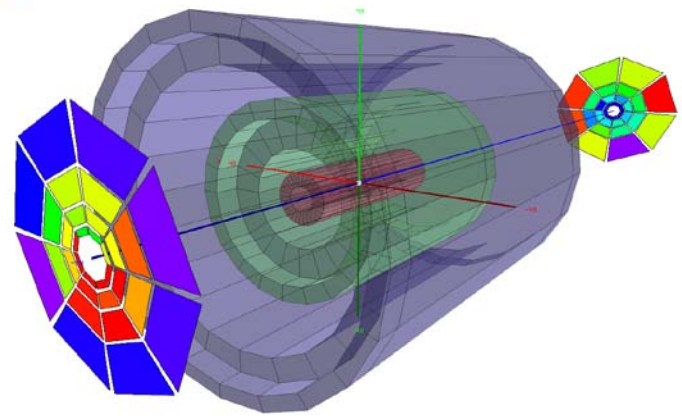

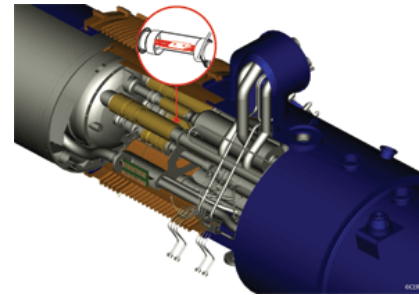
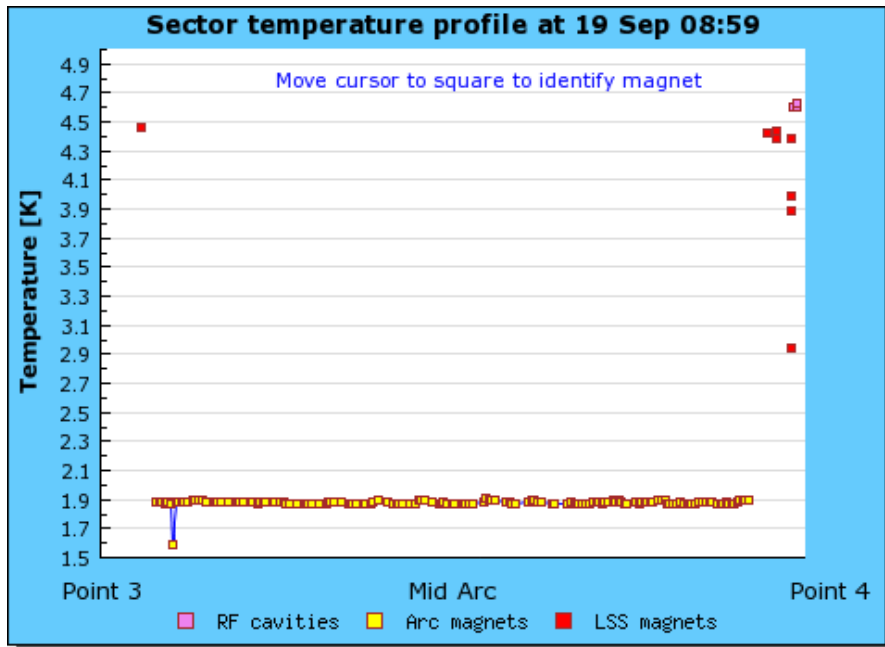

temperature in sector 34

electrical arc between 2 magnets

- important mechanical damage and helium leak
- machine: shutdown for more than a year for repairs
- detectors: commissioning and installation of missing parts

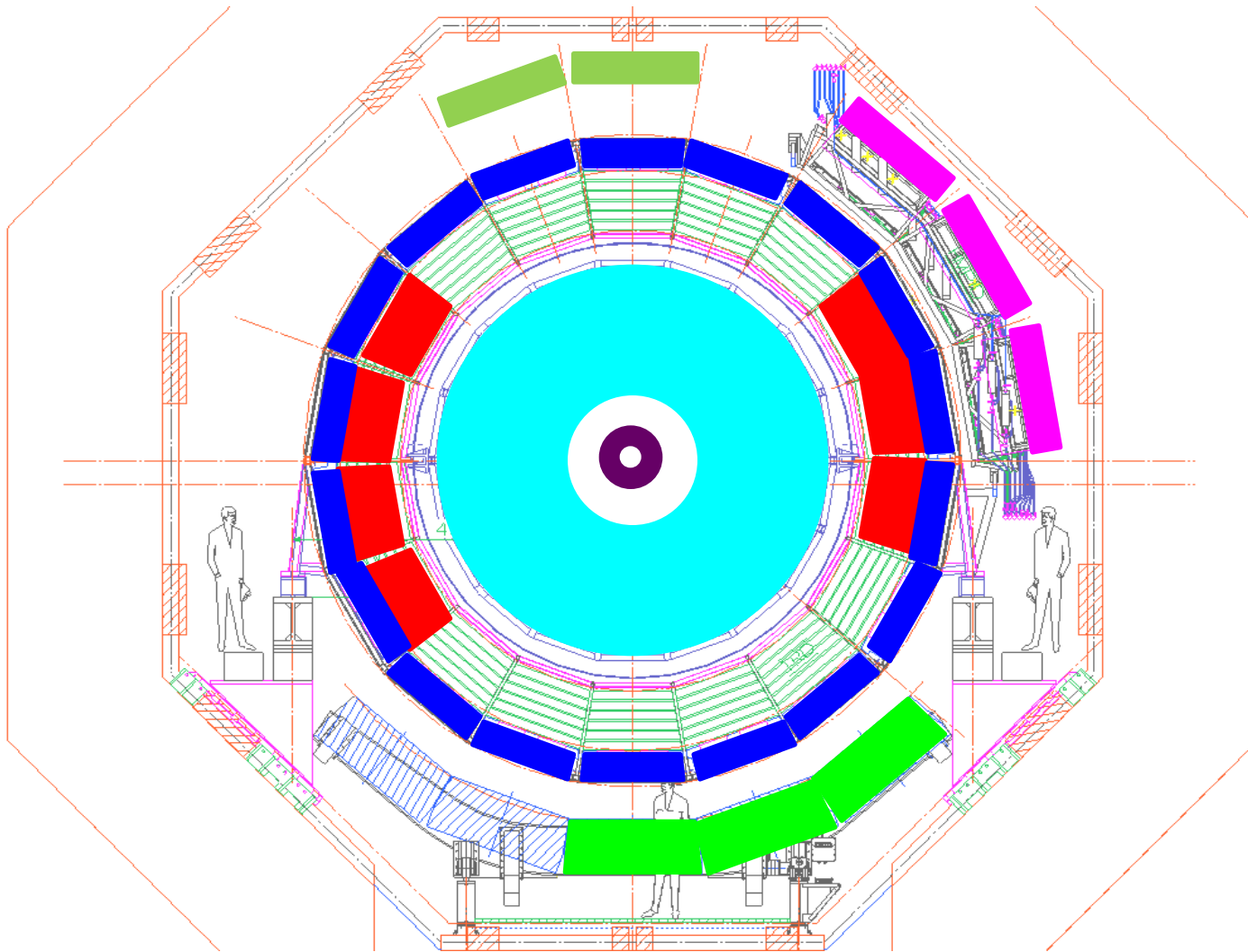
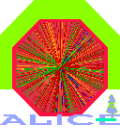

- full: ITS, TPC, TOF, HMPID, MUON, PMD, FMD, T0, V0, ZDC
- partial: TRD (7/18), PHOS (3/5), EMCAL (4/10)

It works!

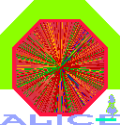

November 23th 2009 16:47, first proton-proton collision

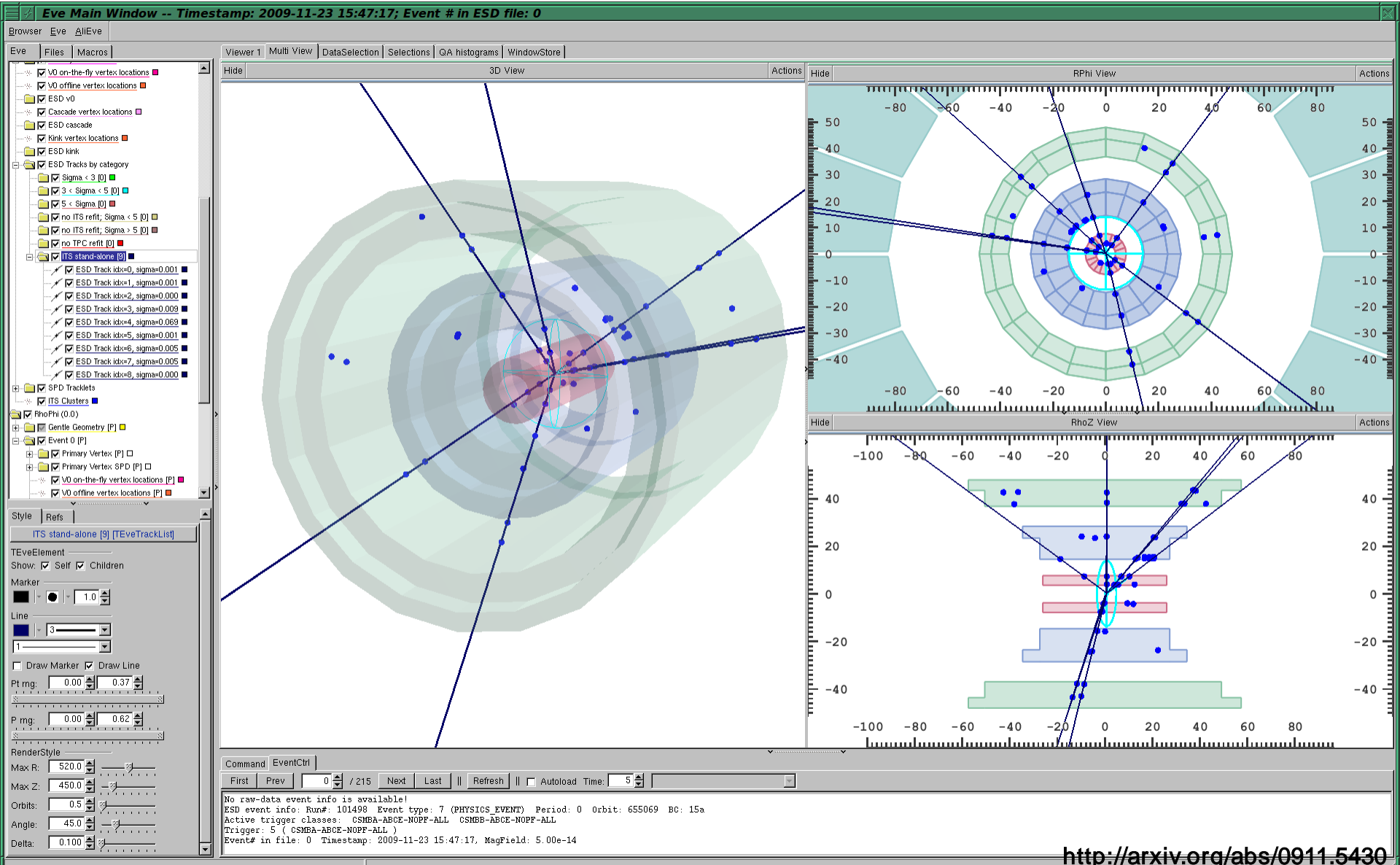

<http://arxiv.org/abs/0911.5430>

It works!



<http://aliceinfo.cern.ch/Collaboration/index.html>

The first (LHC) ALICE paper

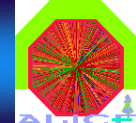

The European Physical Journal

volume 65 - numbers 1-2 - January - 2010

EPJ C



Particles and Fields



ALICE

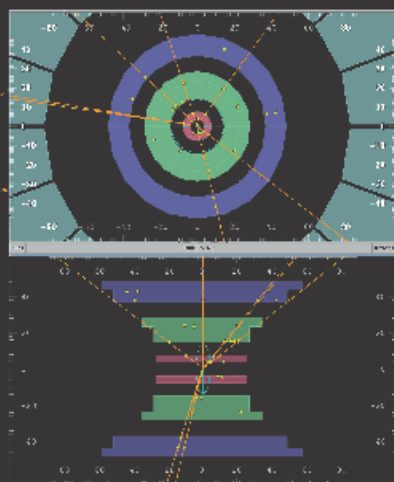

The first pp collision candidate shown by the event display in the ALICE counting room (3D view, $r-\phi$ and $r-z$ projections), the dimensions are shown in cm. The dots correspond to hits in the silicon vertex detectors (SPD, SDD and SSD), the lines correspond to tracks reconstructed using loose quality cuts. From the ALICE Collaboration: First proton-proton collisions at the LHC as observed with the ALICE detector: measurement of the charged particle pseudorapidity density at $\sqrt{s} = 900$ GeV



Eur. Phys. J. C (2010) 65: 111–125
DOI 10.1140/epjc/s10052-009-1227-4

THE EUROPEAN
PHYSICAL JOURNAL C

Regular Article - Experimental Physics

First proton–proton collisions at the LHC as observed with the ALICE detector: measurement of the charged-particle pseudorapidity density at $\sqrt{s} = 900$ GeV

The ALICE Collaboration

K. Aamodt⁷⁸, N. Abel⁴³, U. Abeyssekera²⁰, A. Abrahantes Quintana⁴², A. Acero⁶³, D. Adamova⁸⁶, M.M. Aggarwal²⁵, G. Aglieri Rinella⁴⁰, A.G. Aghasizadeh¹⁸, S. Aguliar Salazar⁶⁶, Z. Ahammed⁵⁵, A. Ahmad², N. Ahmad², S.U. Ahn^{50,8}, R. Akhmetshin¹⁰⁰, M. Al-Khalili⁶⁸, M. Al-Khalili⁷⁰, M. Al-Khalili¹⁰², M. Al-Khalili¹⁰⁵, M. Al-Khalili⁶⁶, M. Al-Khalili¹¹³

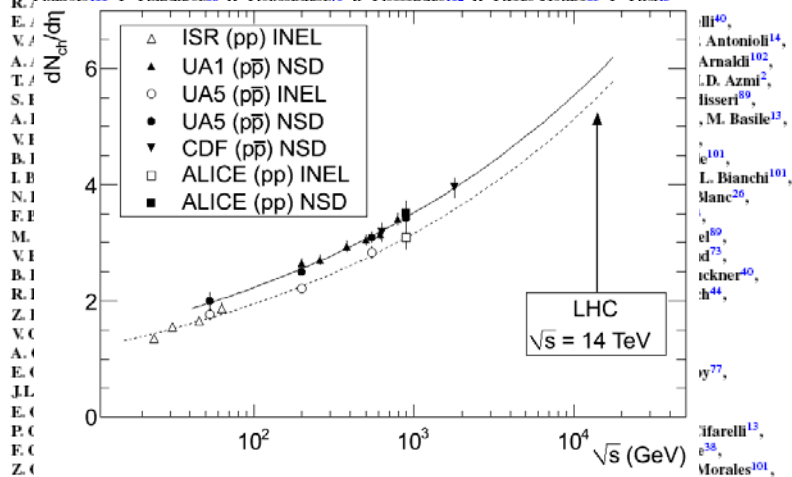

T.M. Cormier³⁴, P. Cortese¹, I. Cortes Maldonado⁸⁴, M.R. Cosentino²¹, F. Costa⁴⁰, M.E. Cotallo⁶³, E. Crescio⁶⁴, P. Crochet²⁶, E. Cuatrecasas⁶⁵, L. Cunqueiro³⁸, J. Cussonneau⁷³, A. Dainese^{59,d}, H.H. Dalgaard²⁸, A. Danu¹⁶, I. Das⁵⁴, S. Das⁵⁴, A. Dash¹¹, S. Dash¹¹, G.O.V. de Barros⁹³, A. De Caro⁹⁰, G. de Cataldo^{40,n}, J. de Cuveland^{43,c}, A. De Falco¹⁹, M. de Gascari⁴⁴, I. de Groot⁴⁰, D. De Gruttola⁹⁰, A. P. De Haze¹⁰⁶, N. De Marco¹⁰², P. De Rossi¹⁰⁶

- data taken on Nov. 23th (284 events in 43 minutes)
- paper submitted on Nov. 28th
- paper accepted on Dec. 1st

<http://arxiv.org/abs/0911.5430>

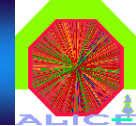

ALICE is fully operational and has already taken (and published) proton-proton data

Plans for 2010:

- **LHC restarts in February with proton beams**
- **first heavy-ion beams in November**